

Phage Display

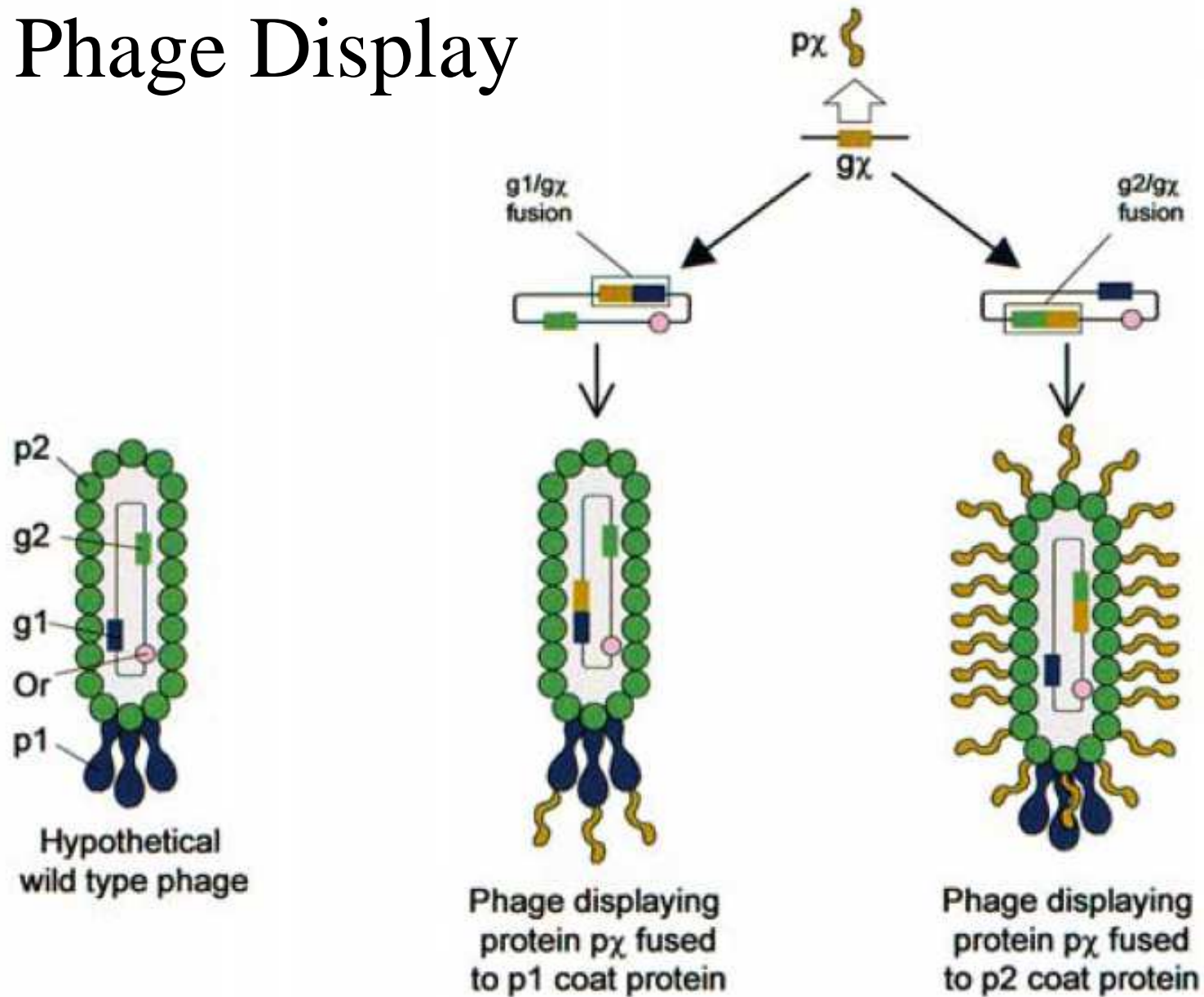

Phage Display

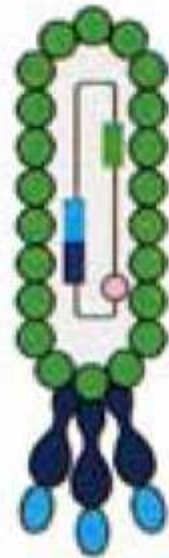

Natural peptides

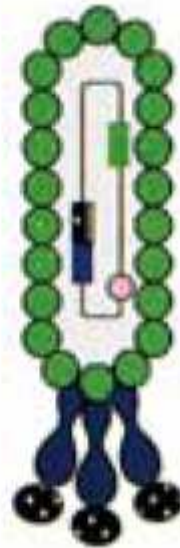

Synthetic random peptides



Protein domains & whole proteins

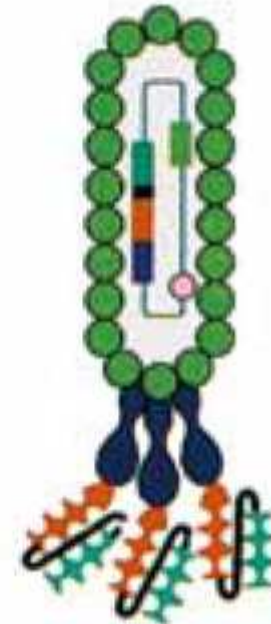

Antibody fragments

Phage Display

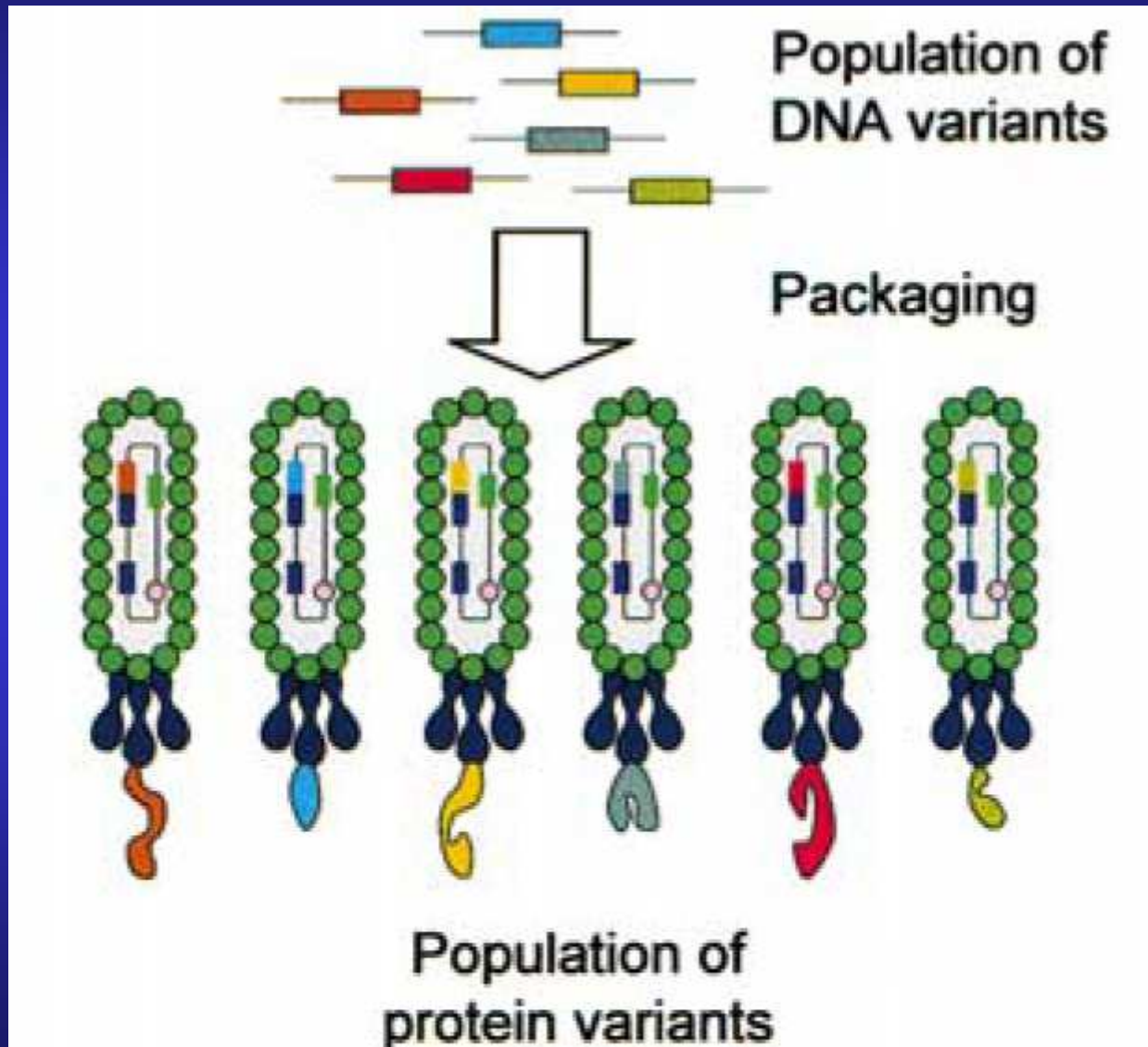

Phage Display

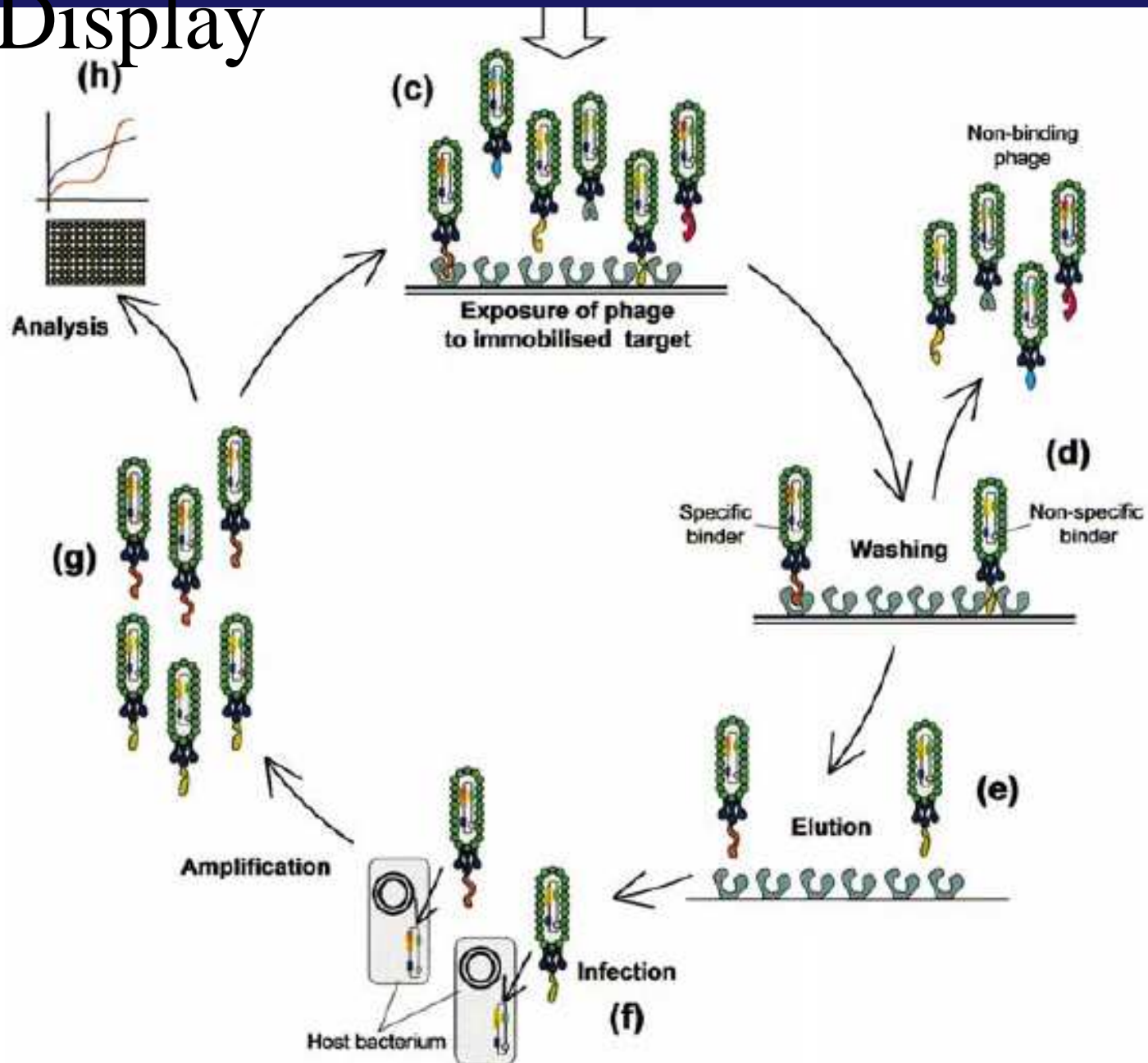

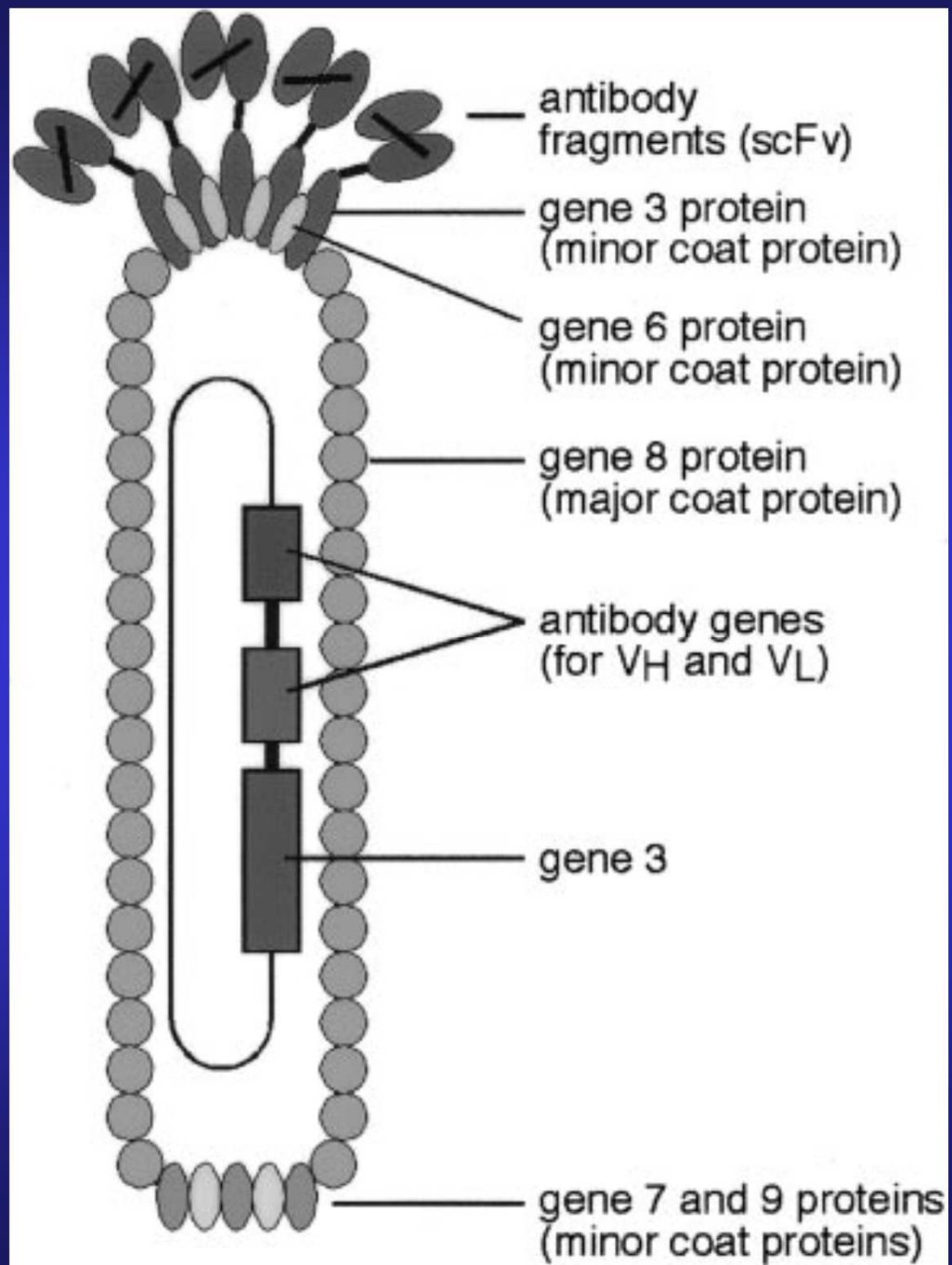

Model of FVIIa protease domain with A-183 + extension peptide X ?

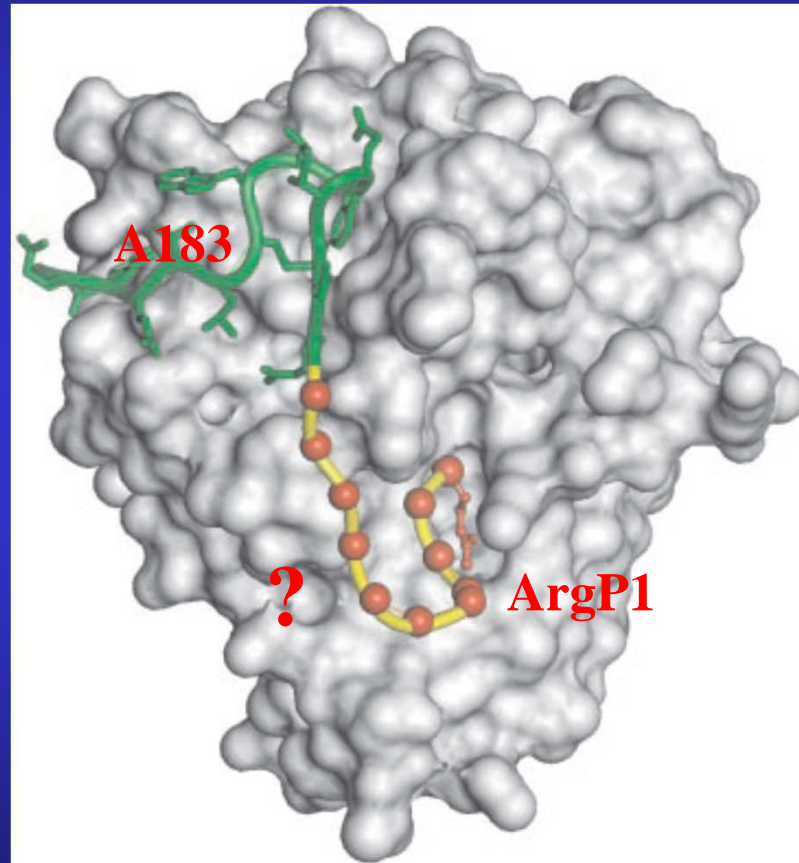

A chimeric peptide with a high degree of specificity and potency:
exosite interactions (A183, 15mer) + greater steric hindrance in the substrate binding cleft + higher affinity due to a more extensive binding surface

determinanti di specificità di proteasi

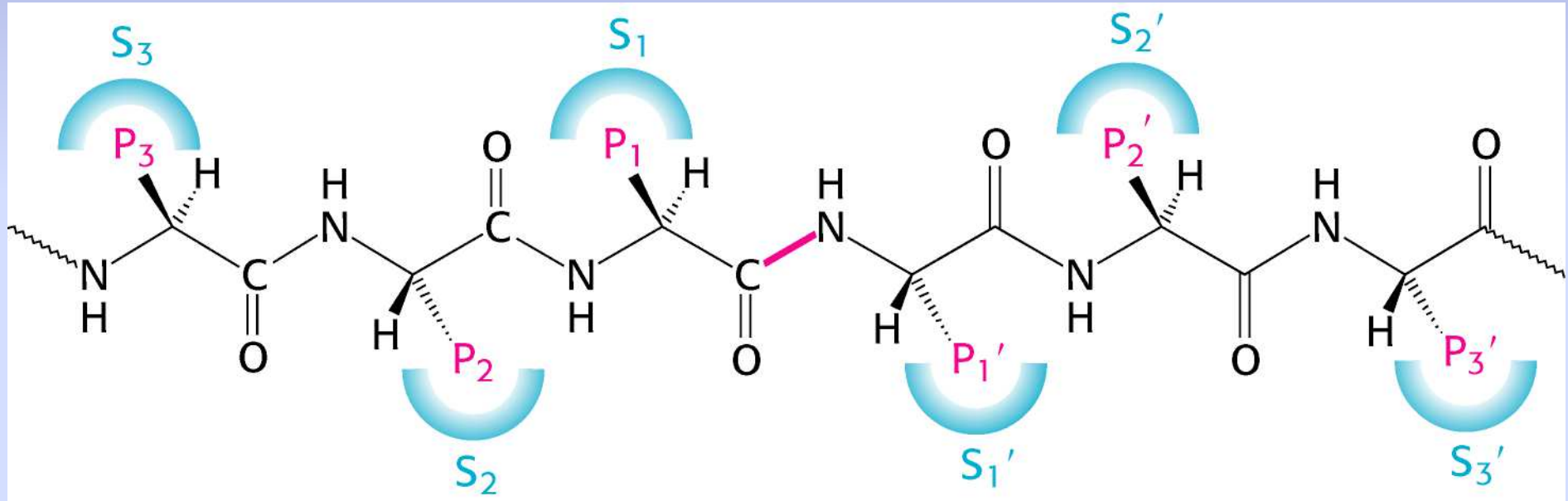
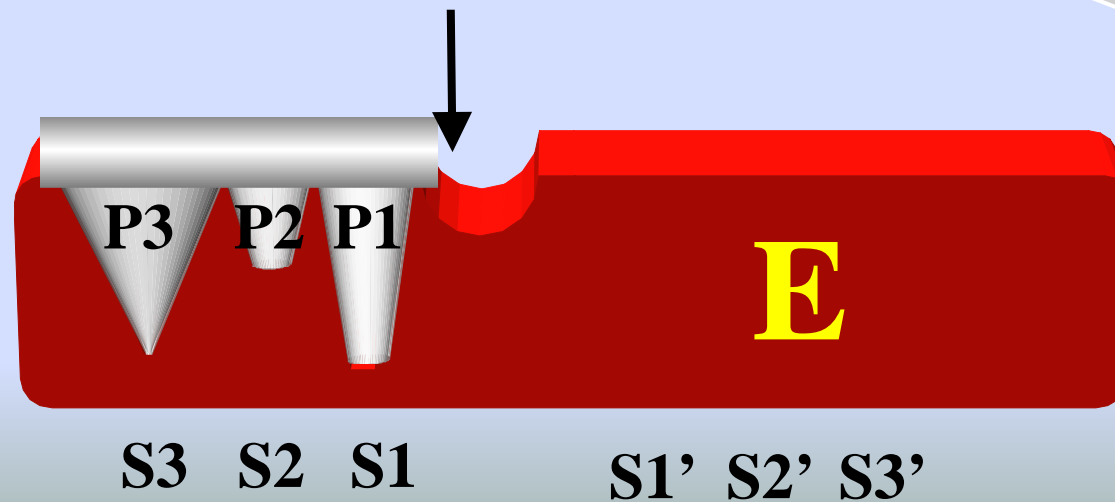
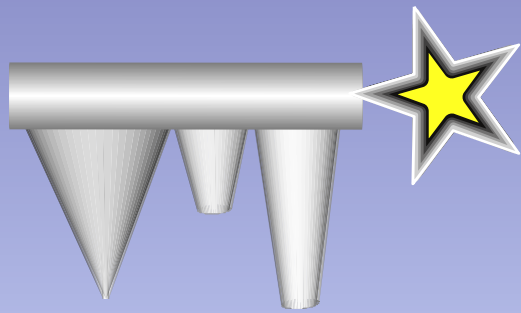

Table 1 Sites of cleavage in the human vitamin K-dependent zymogens*

Enzyme	Substrate†	P ₄	P ₃	P ₂	P ₁	↓	P ₁ '	P ₂ '	P ₃ '	P ₄ '
Xa/Va	II	I	E	G	R		T	A	T	S
	II ₍₁₅₋₁₆₎	I	D	G	R		I	V	E	G
VIIa/TF, IXa/VIIIa	X ₍₁₅₋₁₆₎	N	L	T	R		I	V	G	G
VIIa/TF, XIa	IX	K	L	T	R		A	E	A	V
	IX ₍₁₅₋₁₆₎	D	F	T	R		V	V	G	G
VIIa/TF, Xa	VII ₍₁₅₋₁₆₎	P	Q	G	R		I	V	G	G
IIa/TM	PC ₍₁₅₋₁₆₎	V	D	P	R		L	I	D	G

*Sequences flanking cleavage sites relevant to the activation of the vitamin K-dependent zymogens are presented along with the relevant enzymes that catalyze these reactions. The site of bond cleavage is denoted by the arrow. †The site, in each substrate, at which cleavage is required to produce the serine proteinase is indicated as (15–16) corresponding to the homologous residue numbers in chymotrypsinogen [70].





Oligopeptidyl
Substrate

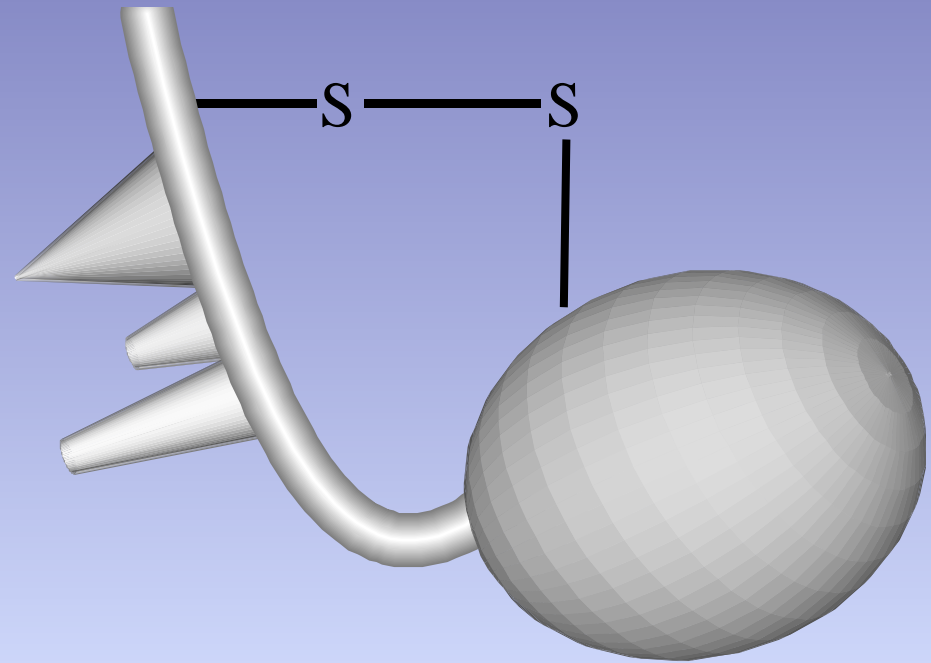

Protein Substrate

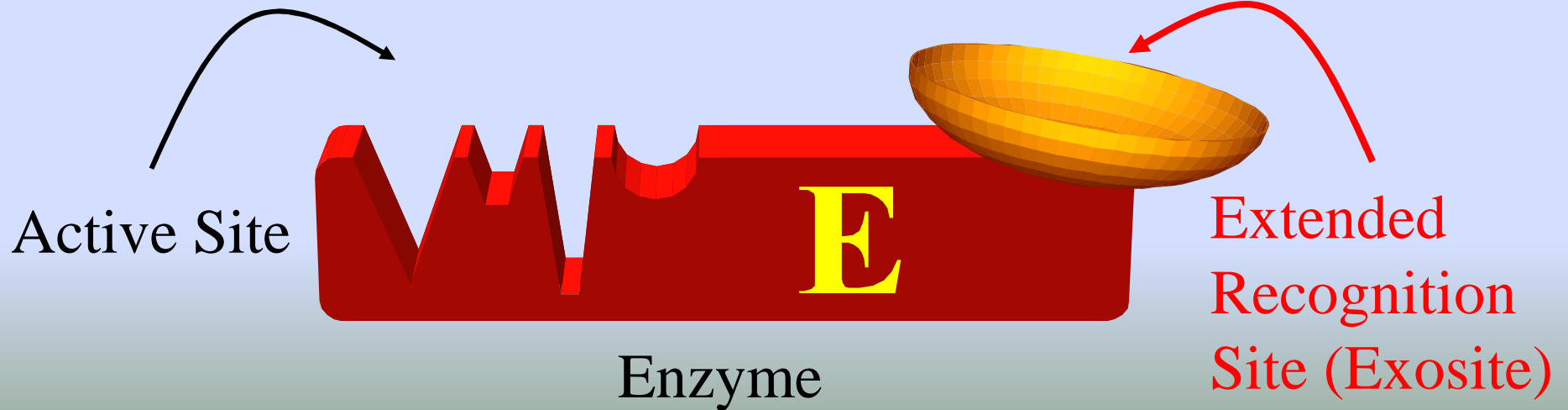

- Libraries A–D designed to determine the length and sequence of the extension to reach into the active site

Inhibitors of Factor VIIa

Position Library	Anchor	Linker library positions														Spacer	Phage coat protein			
		1	2	3	4	5	6	7	8	9	10	12	14	16						
A	A-183	X	X	X	X	X	X	X	a	N	L	T	R	I	V	G	G	protease resistant spacer	p3	
B		X	X	X	X	?	X	X	X	b	L	T	R	I	V	G	G			
C		X	X	X	X	X	X	X	c	T	R	I	V	G	G	-	-			-
D		G	G	S	G	G	S	G	X	X	X	X	X	X	X	G	G			-

a = S, N, K, R; b = N, K; c = L, Q

Peptide Inhibitors of Factor VIIa: Phage binding

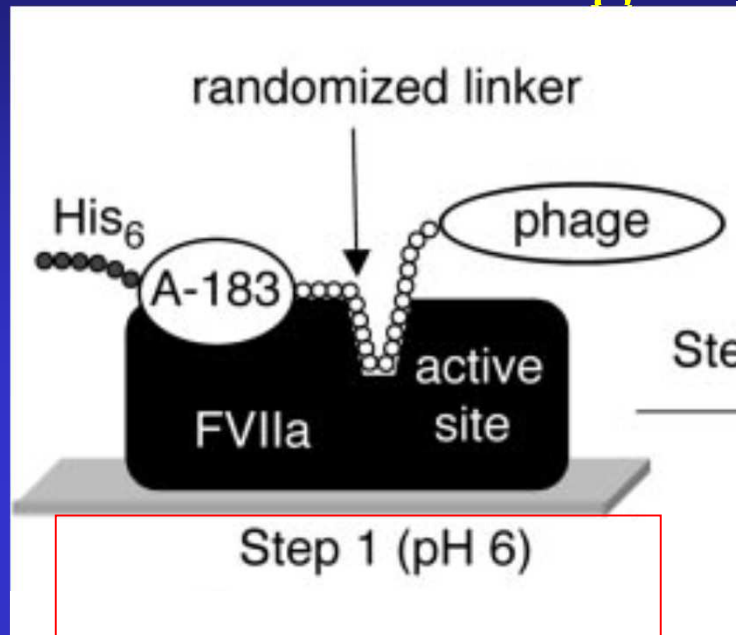

Unbound phage were removed by repetitive washing with binding buffer (step 2).

FVIIa Cleavage conditions

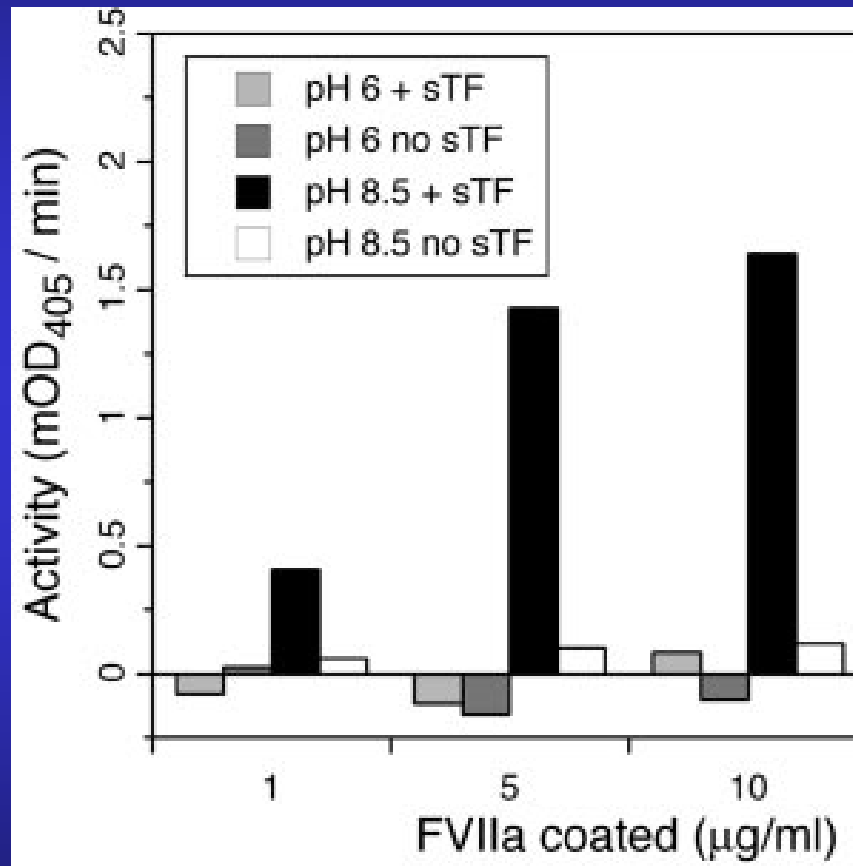

Peptide Inhibitors of Factor VIIa: washing (2) and cleavage (3)

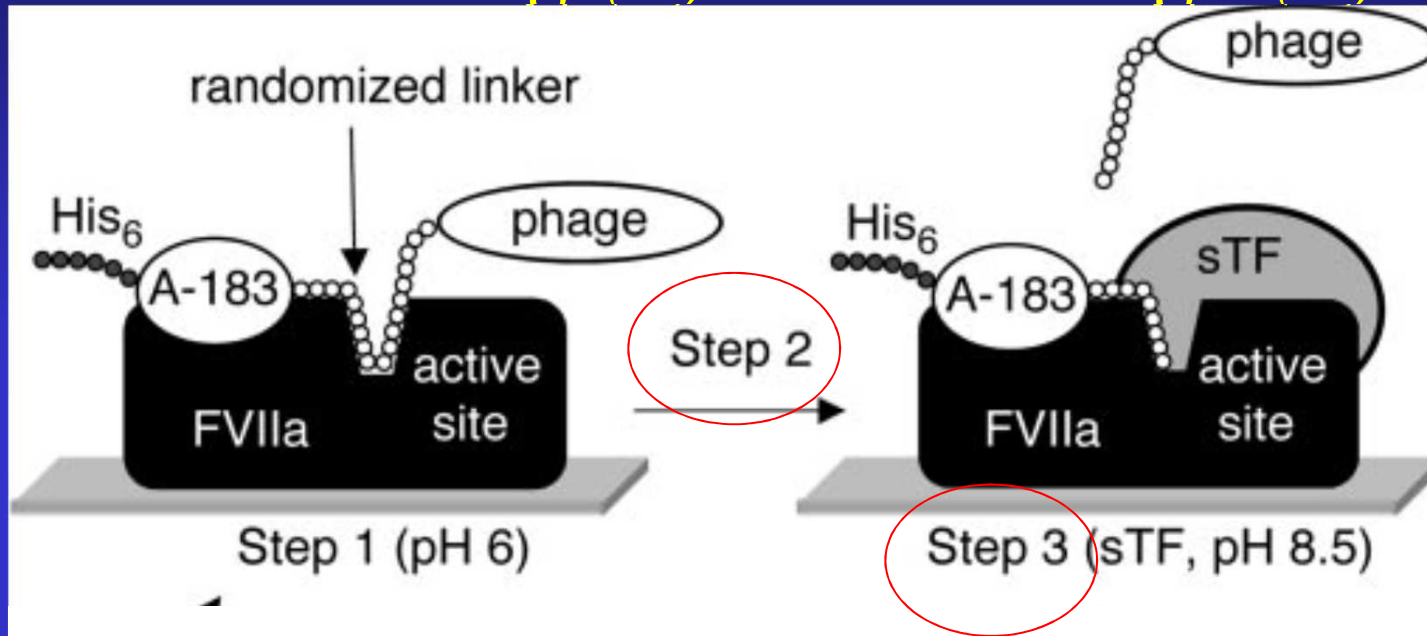

Peptide Inhibitors of Factor VIIa: removal of unbound phages (4)

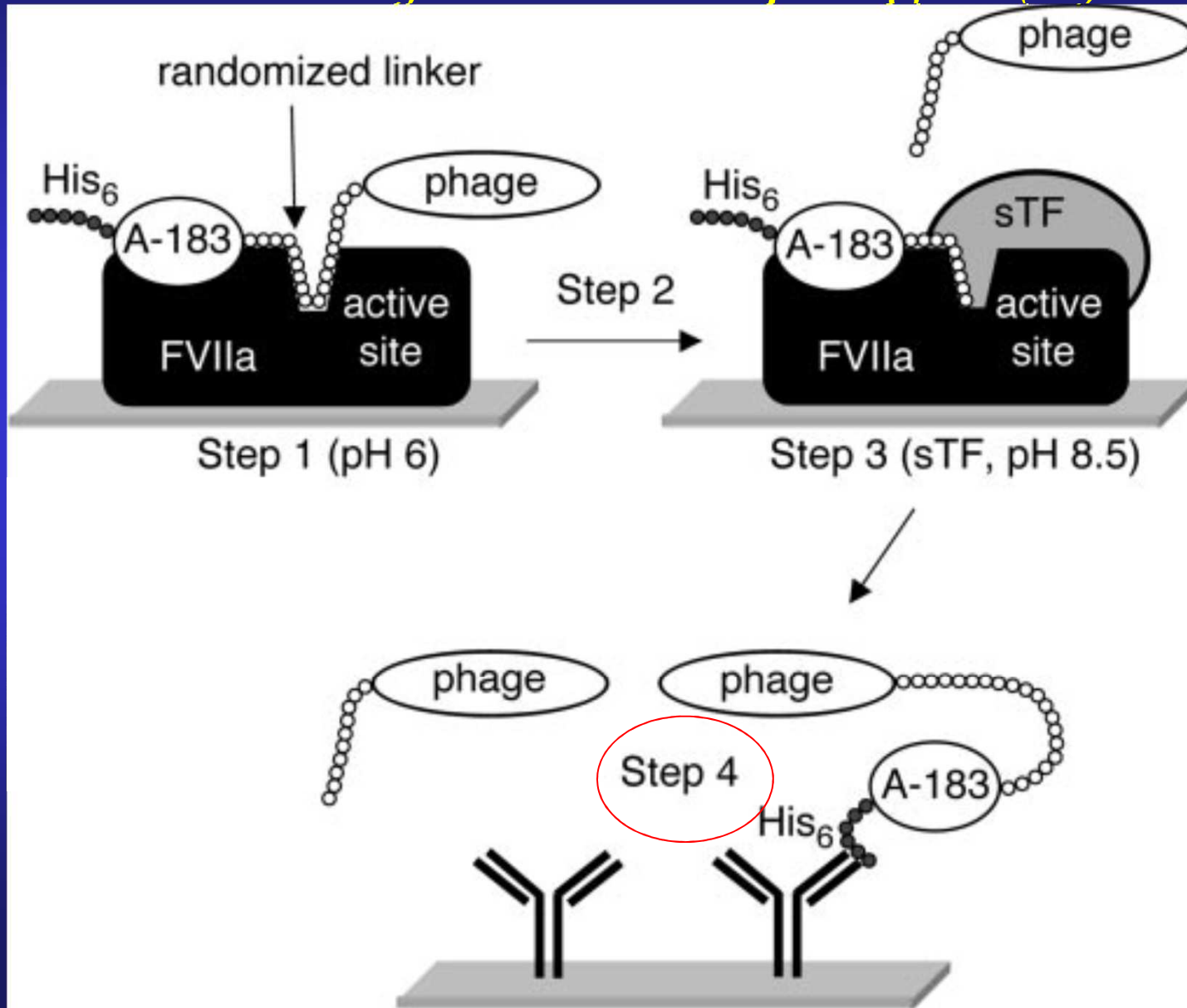

*Peptide Inhibitors of Factor VIIa:
propagation of selected phages and new rounds (5)*

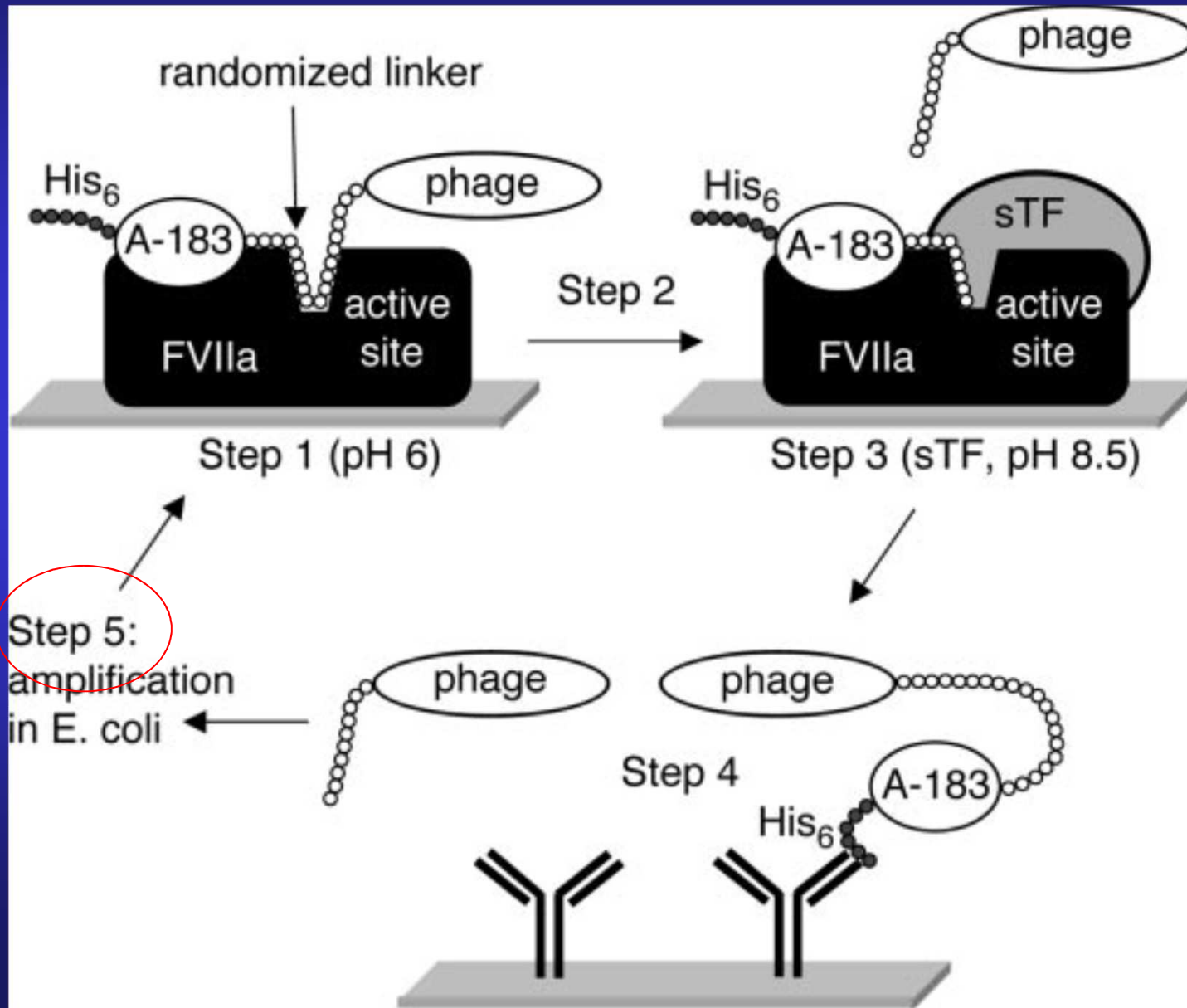

Prolongation of TF-dependent clotting times

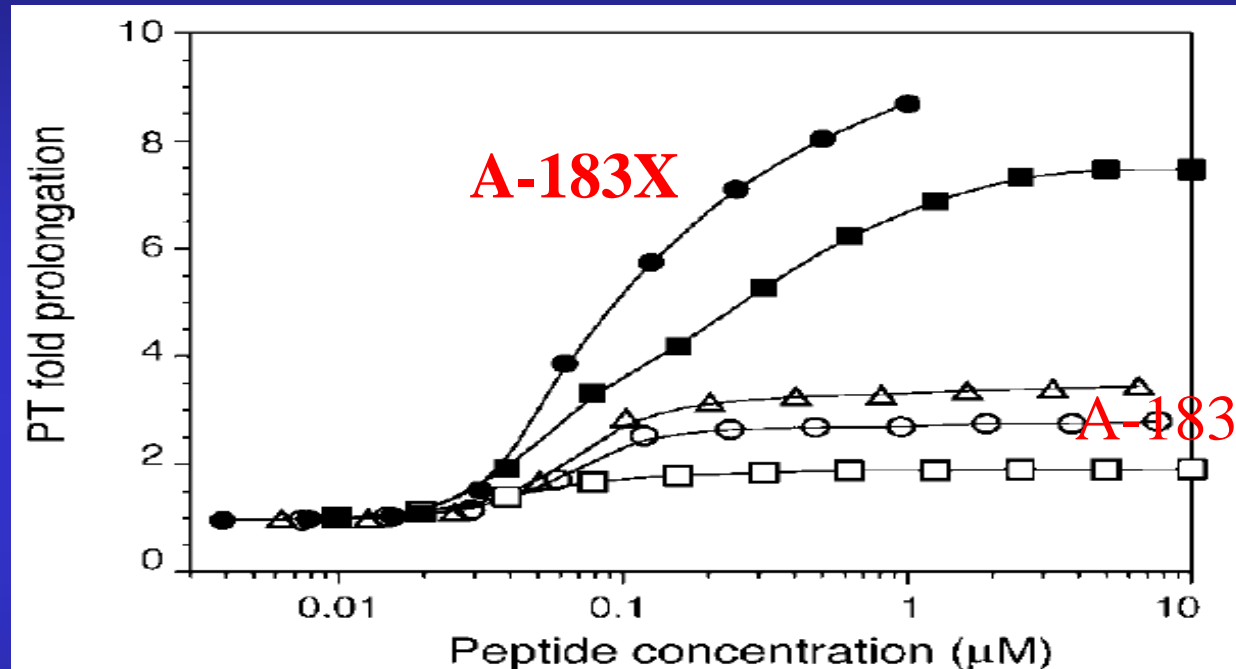

**A-183X was a potent and complete inhibitor of FX activation
maximal extent of inhibition of 99% with an IC₅₀ of 230 pM
(A-183, 74% with an IC₅₀ of 1.5 nM)**

**A-183X also had a maximal prolongation of the prothrombin time of 7.6- *versus*
1.9- fold for A-183, making it a more effective anticoagulant**