

Spectrum Analysis Basics

Christie Brown

Hewlett-Packard Company
Microwave Instruments Division
1400 Fountaingrove Parkway
Santa Rosa, California 95403
U.S.A.

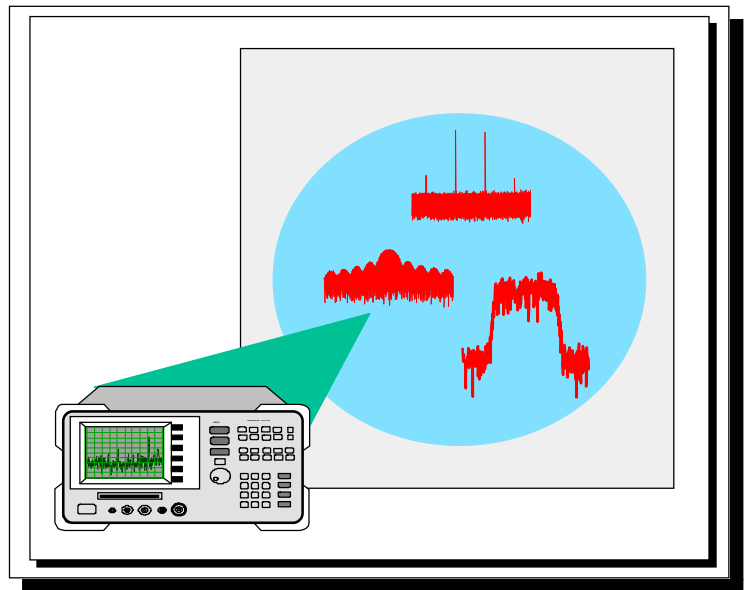

1997 Back to Basics Seminar

Abstract

Learn why spectrum analysis is important for a variety of applications and how to measure system and device performance using a spectrum analyzer. To introduce you to spectrum analyzers, the theory of operation will be discussed. In addition, the major components inside the analyzer and why they are important will be examined. Next, you will learn the spectrum analyzer specifications that are important for your application. Finally, features of a spectrum analyzer that make it more effective in making measurements will be introduced.

Author

Christie Brown is a Business Development Engineer at the Microwave Instruments Division of Hewlett-Packard. She received her BSEE from San Jose State University in 1986, and her MBA/MS Engineering from California Polytechnic University, San Luis Obispo, in 1993. Christie worked as a Test Engineer for Lockheed Missiles & Space Company for two and a half years, and as a Technical Sales Engineer for Coherent, Inc., a laser manufacturing company, for two and a half years. Christie joined Hewlett-Packard in 1993 as a Regional Sales Engineer, and is now working on various projects in the wireless communications market.

Spectrum Analysis Basics

Slide #1

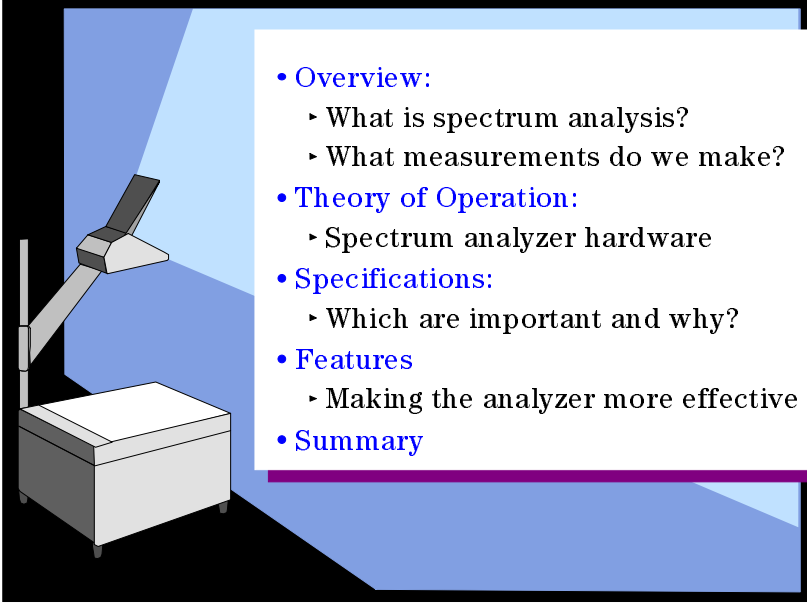

Agenda

- Overview:
 - What is spectrum analysis?
 - What measurements do we make?
- Theory of Operation:
 - Spectrum analyzer hardware
- Specifications:
 - Which are important and why?
- Features
 - Making the analyzer more effective
- Summary

 HEWLETT
PACKARD Spectrum Analysis Basics
CMB 1296

This paper is intended to be a beginning tutorial on spectrum analysis. It is written for those who are unfamiliar with spectrum analyzers, and would like a basic understanding of how they work, what you need to know to use them to their fullest potential, and how to make them more effective for particular applications.

It is written for new engineers and technicians, therefore a basic understanding of electrical concepts is recommended.

We will begin with an overview of spectrum analysis. In this section, we will define spectrum analysis as well as present a brief introduction to the types of tests that are made with a spectrum analyzer.

From there, we will learn about spectrum analyzers in terms of the hardware inside, what the importance of each component is, and how it all works together.

In order to make measurements on a spectrum analyzer and to interpret the results correctly, it is important to understand the characteristics of the analyzer. Spectrum analyzer specifications will help you determine if a particular instrument will make the measurements you need to make, and how accurate the results will be.

Spectrum analyzers also have many additional features that help make them more effective for particular applications. We will discuss briefly, some of the more important and widely used features in this section.

And finally, we will wrap up with a summary.

Spectrum Analysis Basics

Slide #2

Agenda

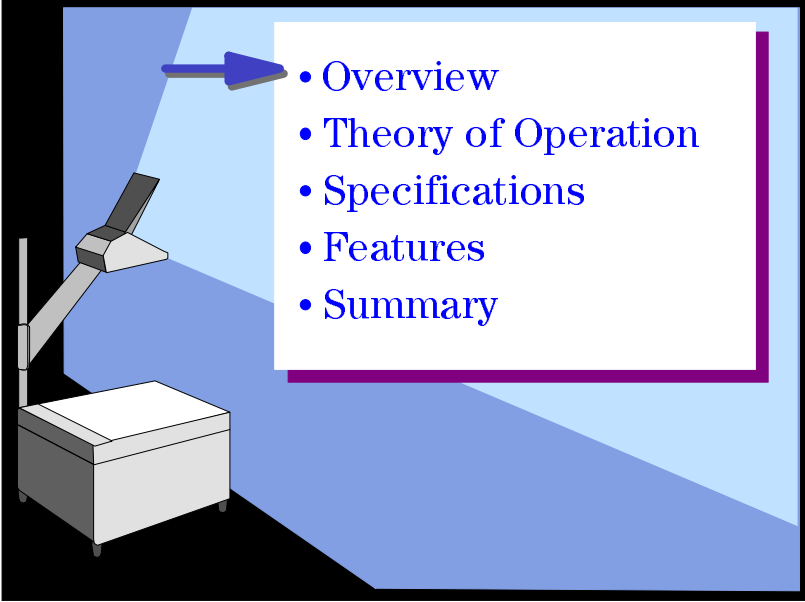
- 
- Overview
 - Theory of Operation
 - Specifications
 - Features
 - Summary

Let's begin with an overview of spectrum analysis.

Spectrum Analysis Basics

Slide #3

Overview

What is Spectrum Analysis?

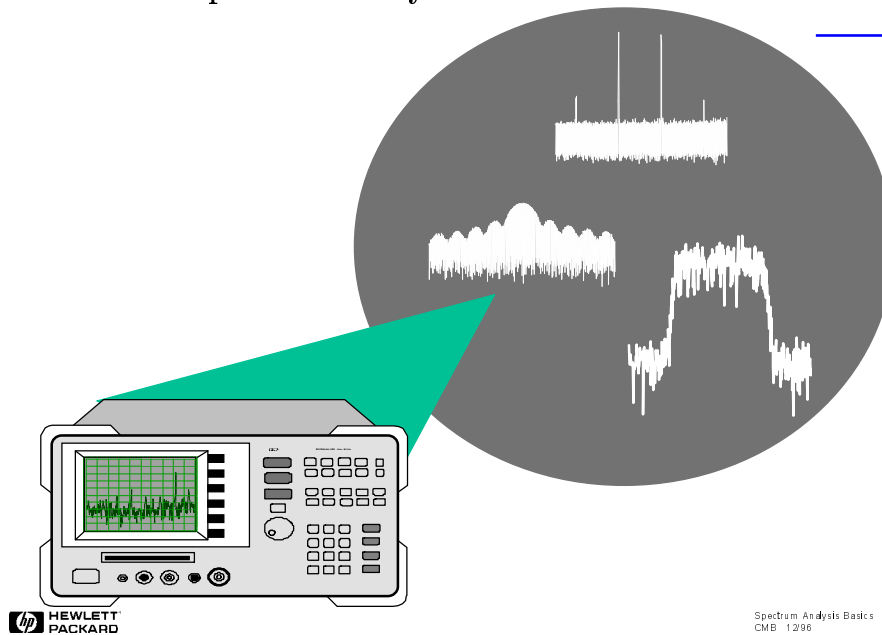

If you are designing, manufacturing, or doing field service/repair of electrical devices or systems, you need a tool that will help you analyze the electrical signals that are passing through or being transmitted by your system or device. By analyzing the characteristics of the signal once its gone through the device/system, you can determine the performance, find problems, troubleshoot, etc.

How do we measure these electrical signals in order to see what happens to them as they pass through our device/system and therefore verify the performance? We need a passive receiver, meaning it doesn't do anything to the signal - it just displays it in a way that makes it easy to analyze the signal. This is called a spectrum analyzer. Spectrum analyzers usually display raw, unprocessed signal information such as voltage, power, period, waveshape, sidebands, and frequency. They can provide you with a clear and precise window into the frequency spectrum.

Depending upon the application, a signal could have several different characteristics. For example, in communications, in order to send information such as your voice or data, it must be modulated onto a higher frequency carrier. A modulated signal will have specific characteristics depending on the type of modulation used. When testing non-linear devices such as amplifiers or mixers, it is important to understand how these create distortion products and what these distortion products look like. Understanding the characteristics of noise and how a noise signal looks compared to other types of signals can also help you in analyzing your device/system.

Understanding the important aspects of a spectrum analyzer for measuring all of these types of signals will help you make more accurate measurements and give you confidence that you are interpreting the results correctly.

Spectrum Analysis Basics

Slide #4

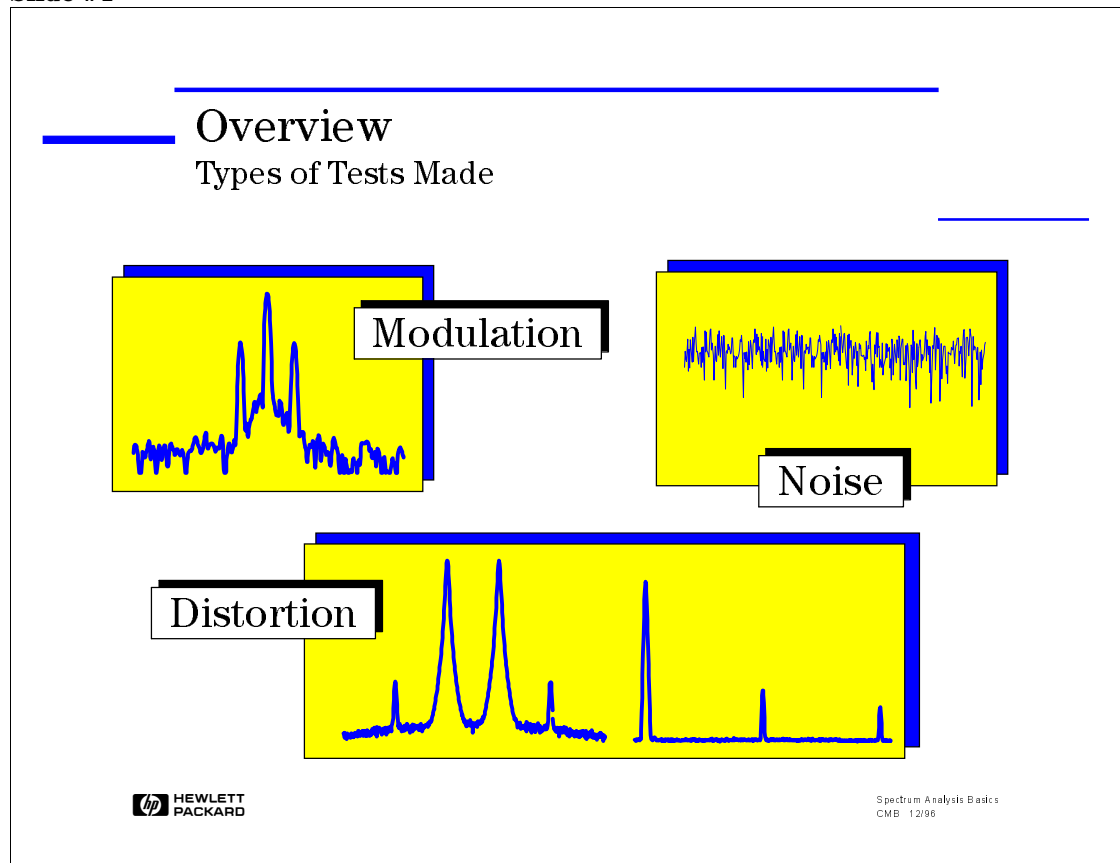

The most common spectrum analyzer measurements are: modulation, distortion, and noise.

Measuring the quality of the modulation is important for making sure your system is working properly and that the information is being transmitted correctly. Understanding the spectral content is important, especially in communications where there is very limited bandwidth. The amount of power being transmitted (for example, to overcome the channel impairments in wireless systems) is another key measurement in communications. Tests such as modulation degree, sideband amplitude, modulation quality, occupied bandwidth are examples of common modulation measurements.

In communications, measuring distortion is critical for both the receiver and transmitter. Excessive harmonic distortion at the output of a transmitter can interfere with other communication bands. The pre-amplification stages in a receiver must be free of intermodulation distortion to prevent signal crosstalk. An example is the intermodulation of cable TV carriers that moves down the trunk of the distribution system and distorts other channels on the same cable. Common distortion measurements include intermodulation, harmonics, and spurious emissions.

Noise is often the signal you want to measure. Any active circuit or device will generate noise. Tests such as noise figure and signal-to-noise ratio (SNR) are important for characterizing the performance of a device and/or its contribution to overall system noise.

For all of these spectrum analyzer measurements, it is important to understand the operation of the spectrum analyzer and the spectrum analyzer performance required for your specific measurement and test specifications. This will help you choose the right analyzer for your application as well as get the most out of it.

Spectrum Analysis Basics

Slide #5

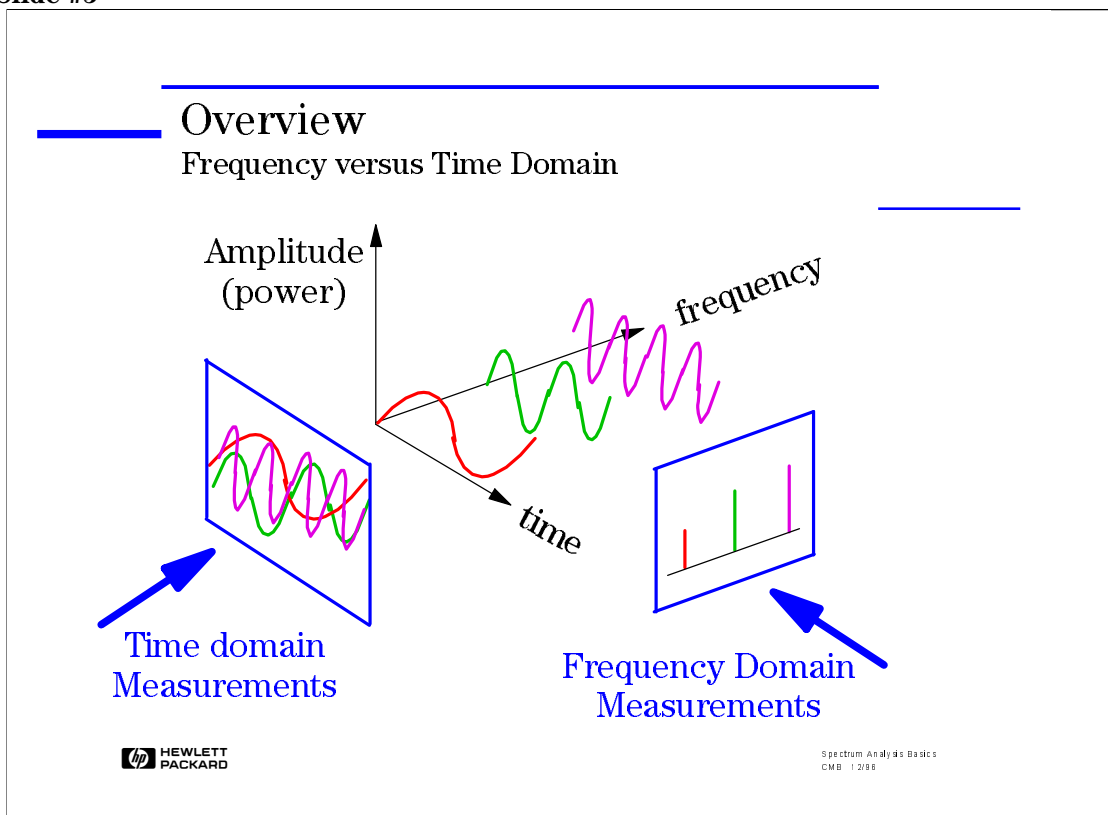

Traditionally, when you want to look at an electrical signal, you use an oscilloscope to see how the signal varies with time. This is very important information; however, it doesn't give you the full picture. To fully understand the performance of your device/system, you will also want to analyze the signal(s) in the frequency-domain. This is a graphical representation of the signal's amplitude as a function of frequency. The spectrum analyzer is to the frequency domain as the oscilloscope is to the time domain. (It is important to note that spectrum analyzers can also be used in the fixed-tune mode (zero span) to provide time-domain measurement capability much like that of an oscilloscope.)

The figure shows a signal in both the time and the frequency domains. In the time domain, all frequency components of the signal are summed together and displayed. In the frequency domain, complex signals (that is, signals composed of more than one frequency) are separated into their frequency components, and the level at each frequency is displayed.

Frequency domain measurements have several distinct advantages. For example, let's say you're looking at a signal on an oscilloscope that appears to be a pure sine wave. A pure sine wave has no harmonic distortion. If you look at the signal on a spectrum analyzer, you may find that your signal is actually made up of several frequencies. What was not discernible on the oscilloscope becomes very apparent on the spectrum analyzer.

Some systems are inherently frequency domain oriented. For example, many telecommunications systems use what is called Frequency Division Multiple Access (FDMA) or Frequency Division Multiplexing (FDM). In these systems, different users are assigned different frequencies for transmitting and receiving, such as with a cellular phone. Radio stations also use FDM, with each station in a given geographical area occupying a particular frequency band. These types of systems must be analyzed in the frequency domain in order to make sure that no one is interfering with users/radio stations on neighboring frequencies. We shall also see later how measuring with a frequency domain analyzer can greatly reduce the amount of noise present in the measurement because of its ability to narrow the measurement bandwidth.

From this view of the spectrum, measurements of frequency, power, harmonic content, modulation, spurs, and noise can easily be made. Given the capability to measure these quantities, we can determine total harmonic distortion, occupied bandwidth, signal stability, output power, intermodulation distortion, power bandwidth, carrier-to-noise ratio, and a host of other measurements, using just a spectrum analyzer.

Spectrum Analysis Basics

Slide #6

Overview

Different Types of Analyzers

Fourier Analyzer

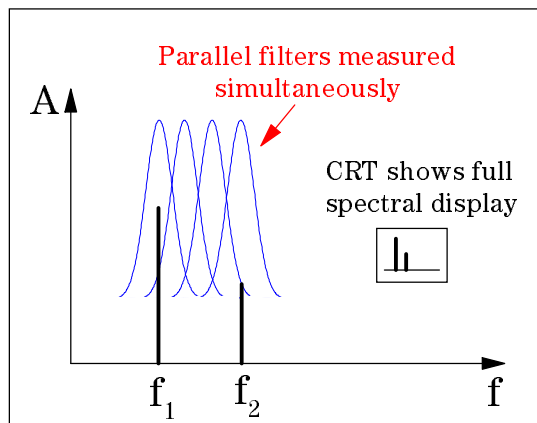

Now that we understand why spectrum analyzers are important, let's take a look at the different types of analyzers available for measuring RF.

There are basically two ways to make frequency domain measurements (what we call spectrum analysis): Fourier transform and swept-tuned.

The Fourier analyzer basically takes a time-domain signal, digitizes it using digital sampling, and then performs the mathematics required to convert it to the frequency domain*, and display the resulting spectrum. It is as if the analyzer is looking at the entire frequency range at the same time using parallel filters measuring simultaneously. It is actually capturing the time domain information which contains all the frequency information in it. With its real-time signal analysis capability, the Fourier analyzer is able to capture periodic as well as random and transient events. It also can provide significant speed improvement over the more traditional swept analyzer and can measure phase as well as magnitude. However it does have its limitations, particularly in the areas of frequency range, sensitivity, and dynamic range. We shall discuss what these terms are and why they are important in a later section.

Fourier analyzers are becoming more prevalent, as analog-to-digital converters (ADC) and digital signal processing (DSP) technologies advance. Operations that once required a lot of custom, power-hungry discrete hardware can now be performed with commercial off-the-shelf DSP chips, which get smaller and faster every year. These analyzers can offer significant performance improvements over conventional spectrum analyzers, but often with a price premium.

* The frequency domain is related to the time domain by a body of knowledge generally known as Fourier theory (named for Jean Baptiste Joseph Fourier, 1768-1830). Discrete, or digitized signals can be transformed into the frequency domain using the *discrete Fourier transform*.

Spectrum Analysis Basics

Slide #7

Overview Different Types of Analyzers

Swept Analyzer

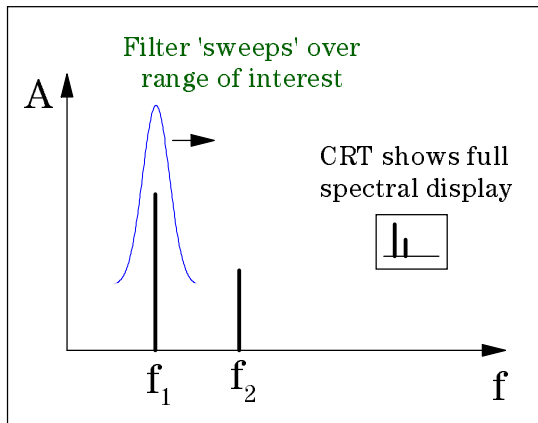

The most common type of spectrum analyzer is the swept-tuned receiver. It is the most widely accepted, general-purpose tool for frequency-domain measurements. The technique most widely used is superheterodyne. Heterodyne means to mix - that is, to translate frequency - and super refers to super-audio frequencies, or frequencies above the audio range. Very basically, these analyzers "sweep" across the frequency range of interest, displaying all the frequency components present. We shall see how this is actually accomplished in the next section. The swept-tuned analyzer works just like the AM radio in your home except that on your radio, the dial controls the tuning and instead of a display, your radio has a speaker.

The swept receiver technique enables frequency domain measurements to be made over a large dynamic range and a wide frequency range, thereby making significant contributions to frequency-domain signal analysis for numerous applications, including the manufacture and maintenance of microwave communications links, radar, telecommunications equipment, cable TV systems, and broadcast equipment; mobile communication systems; EMI diagnostic testing; component testing; and signal surveillance.

For the remainder of this paper, the term *spectrum analyzer* will refer only to the swept tuned analyzer. This is the type of analyzer that we will learn about in detail.

Spectrum Analysis Basics

Slide #8

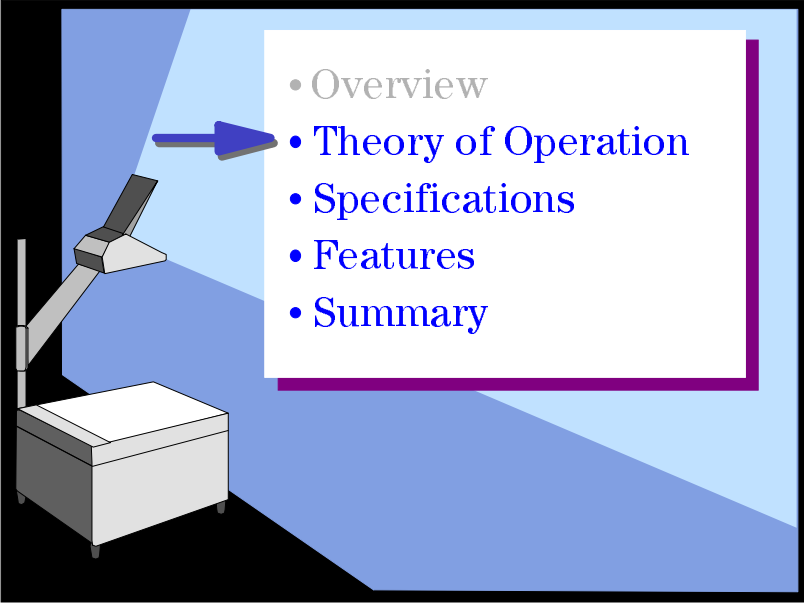

The slide features a central illustration of a projector screen displaying an agenda. A blue arrow points from the screen to the right. The agenda items are listed in blue text. The slide is framed by blue lines and includes the HP logo and product information at the bottom.

Agenda

- Overview
- Theory of Operation
- Specifications
- Features
- Summary

 HEWLETT
PACKARD

Spectrum Analysis Basics
CMB 12/96

Based on the previous slide, you might be picturing the inside of the analyzer consisting of a bandpass filter that sweeps across the frequency range of interest. If the input signal is say, 1 MHz, then when the bandpass filter passes over 1 MHz, it will "see" the input signal and display it on the screen.

Although this concept would work, it is very difficult and therefore expensive to build a filter which tunes over a wide range. An easier, and therefore less expensive, implementation is to use a tunable local oscillator (LO), and keep the bandpass filter fixed. We will see when we go into more detail, that in this concept, we are sweeping the input signal past the fixed filter, and as it passes through the fixed bandpass filter, it is displayed on the screen. Don't worry if it seems confusing now - as we discuss the block diagram, the concept will become clearer.

Let's now go into more detail as to how the swept spectrum analyzer works.

Spectrum Analysis Basics

Slide #9

Theory of Operation Spectrum Analyzer Block Diagram

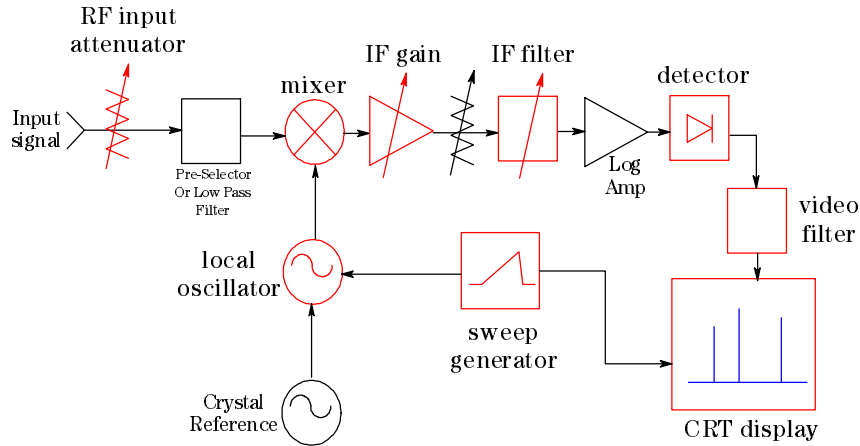

The major components in a spectrum analyzer are the RF input attenuator, mixer, IF (Intermediate Frequency) gain, IF filter, detector, video filter, local oscillator, sweep generator, and CRT display. Before we talk about how these pieces work together, let's get a fundamental understanding of each component individually.

Spectrum Analysis Basics

Slide #10

Theory of Operation Mixer

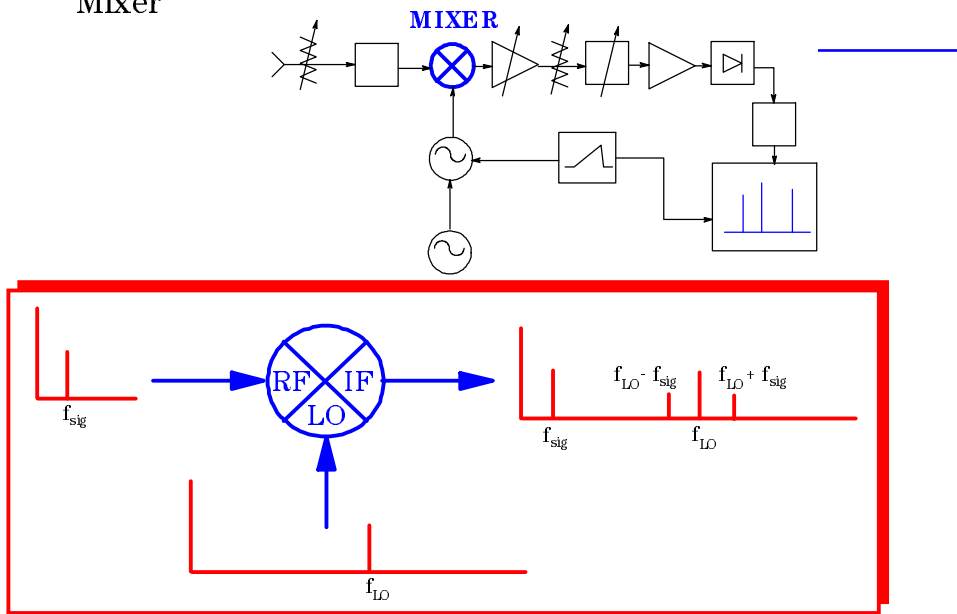

A mixer is a device that converts a signal from one frequency to another. Therefore, it is sometimes called a frequency-translation device.

By definition, a mixer is a non-linear device (frequencies are present at the output that were not present at the input). The local oscillator signal (f_{LO}) is applied to one port of the mixer and the signal to be converted (f_{sig}) is applied to the second port. The output of a mixer consists of the two original signals (f_{sig} and f_{LO}) as well as the sum ($f_{LO} + f_{sig}$) and difference ($f_{LO} - f_{sig}$) frequencies of these two signals.

In a spectrum analyzer, the difference frequency is actually the frequency of interest. The mixer has converted our RF input signal to an IF (Intermediate Frequency) signal that the analyzer can now filter, amplify and detect for the purpose of displaying the signal on the screen. We will see how this is done shortly.

Spectrum Analysis Basics

Slide #11

Theory of Operation

IF Filter

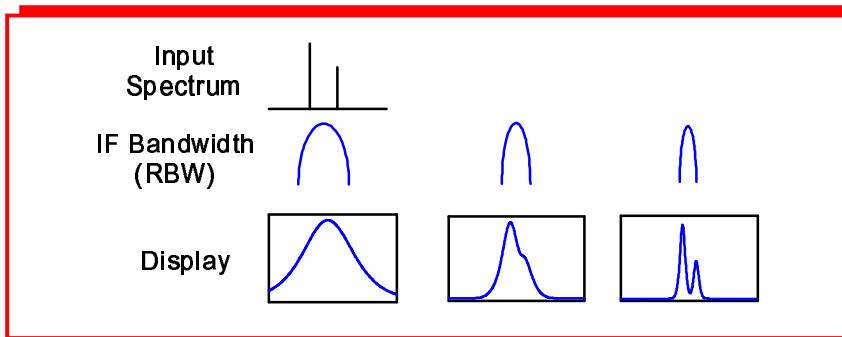
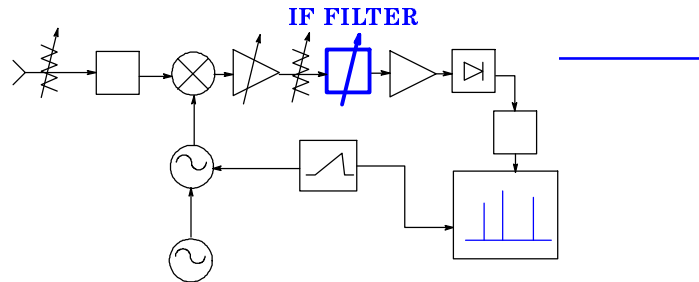

The IF filter is a bandpass filter which is used as the "window" for detecting signals. It's bandwidth is also called the resolution bandwidth (RBW) of the analyzer and can be changed via the front panel of the analyzer.

By giving you a broad range of variable resolution bandwidth settings, the instrument can be optimized for the sweep and signal conditions, letting you trade-off frequency selectivity (the ability to resolve signals), signal-to-noise ratio (SNR), and measurement speed.

We can see from the slide that as RBW is narrowed, selectivity is improved (we are able to resolve the two input signals). This will also often improve SNR. The sweep speed and trace update rate, however, will degrade with narrower RBWs. The optimum RBW setting depends heavily on the characteristics of the signals of interest.

Spectrum Analysis Basics

Slide #12

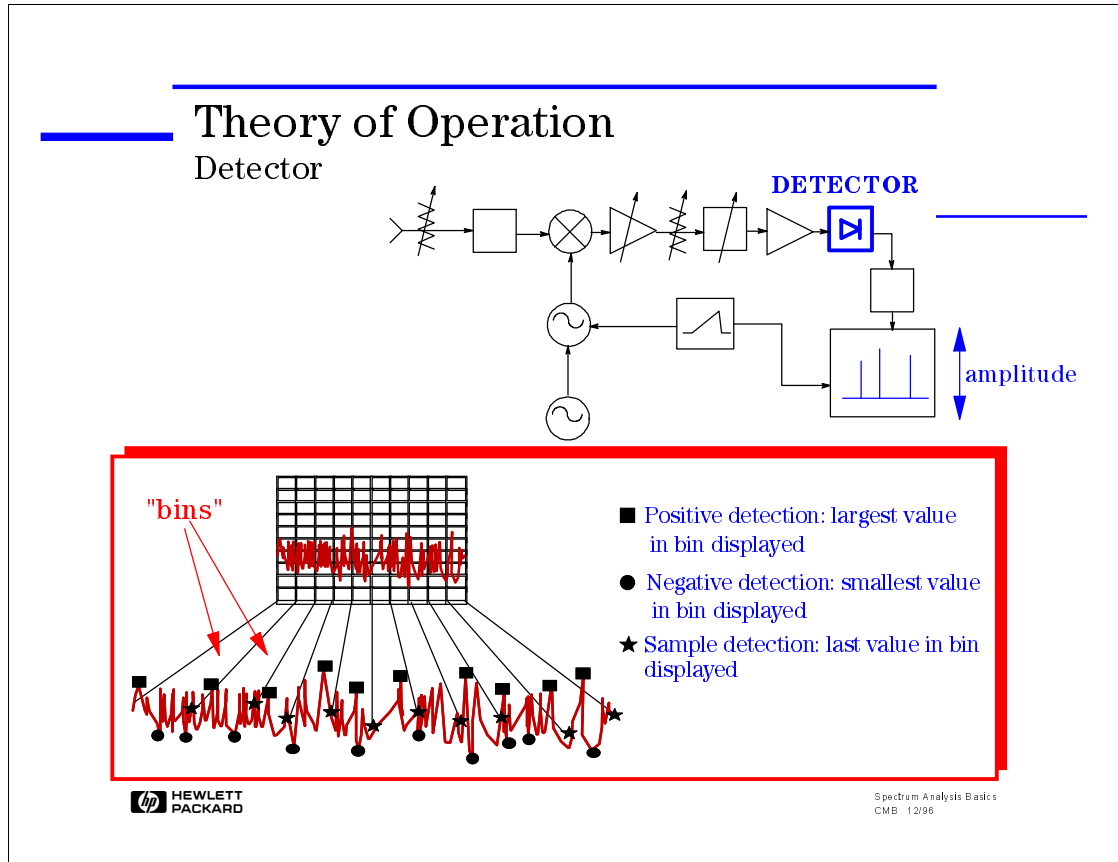

The analyzer must convert the IF signal to a baseband or video signal so it can be viewed on the instrument's display. This is accomplished with an envelope detector which then deflects the CRT beam on the y-axis, or amplitude axis.

Many modern spectrum analyzers have digital displays which first digitize the video signal with an analog-to-digital converter (ADC). This allows for several different detector modes that dramatically effect how the signal is displayed.

The **positive-peak detector mode** captures and displays the peak value of the signal over the duration of one trace element. This mode is good for analyzing sinusoids, but tends to over-respond to noise when no sinusoids are present. Similarly, the **negative-peak detector mode** captures the minimum value of the signal for each bin.

In **sample detection mode**, a random value for each "bin" of data (also called a trace element) is produced. This detector mode is best for computing the rms value of noise or noise-like signals, but it may miss the peaks of burst signals and narrowband signals when the RBW is narrower than the frequency spacing of the bins.

For displaying both signals and noise, a detector mode called the **normal detector mode** (or sometimes the rosenfell detector) is used. In this mode, if the video signal is monotonically increasing or decreasing during the period representing one trace element, then it is assumed that a spectral component is being measured, and positive-peak detection is used. If the signal level is changing non-monotonically during this time (i.e. it rose and fell), then it is assumed that noise is being measured, and trace points alternate between positive- and negative-peak detection. When a minimum value is displayed, the maximum value is saved and compared to the maximum value for the next trace element. The higher of the two values is displayed. This technique provides a better visual display of random noise than peak-detection yet avoids the missed-signal problem of sample-detection.

Spectrum Analysis Basics

Slide #13

Theory of Operation

Video Filter

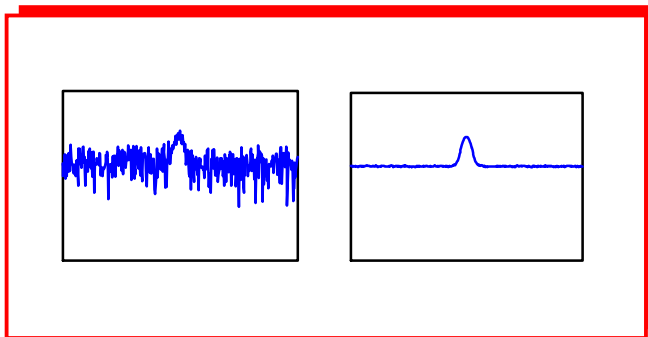
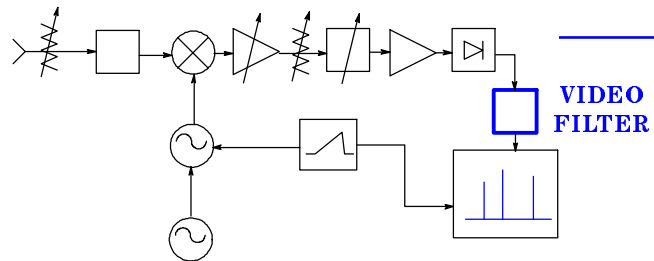

The video filter is a low-pass filter that is located after the envelope detector and before the ADC. This filter determines the bandwidth of the video amplifier, and is used to average or smooth the trace seen on the screen.

The spectrum analyzer displays *signal-plus-noise* so that the closer a signal is to the noise level, the more the noise makes the signal more difficult to read. By changing the video bandwidth (VBW) setting, we can decrease the peak-to-peak variations of noise. This type of display smoothing can be used to help find signals that otherwise might be obscured in the noise.

Spectrum Analysis Basics

Slide #14

Theory of Operation

Other Components

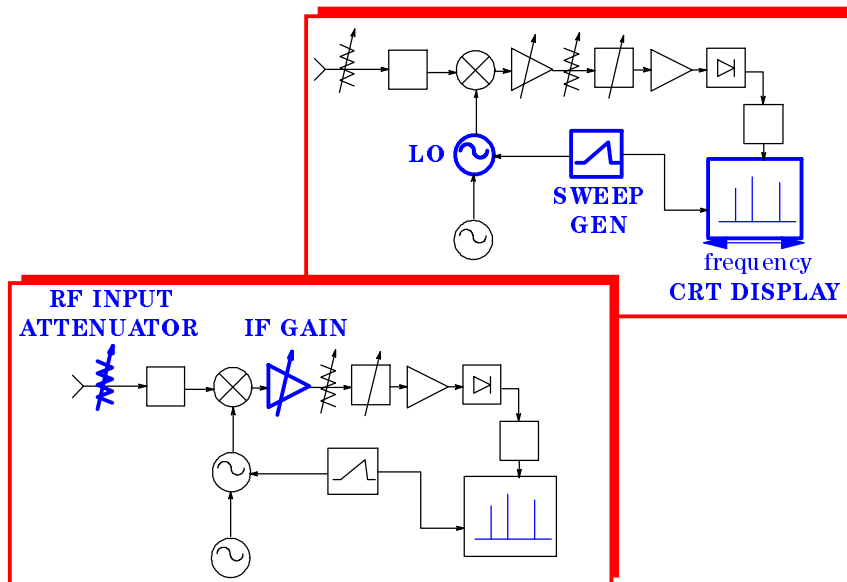

 HEWLETT
PACKARD

Spectrum Analysis Basics
CMB 12/96

And finally, a brief description of the last few components.

The **local oscillator** is a Voltage Controlled Oscillator (VCO) which in effect tunes the analyzer. The **sweep generator** actually tunes the LO so that its frequency changes in proportion to the ramp voltage. This also deflects the CRT beam horizontally across the screen from left to right, creating the frequency domain in the x-axis.

The **RF input attenuator** is a step attenuator located between the input connector and the first mixer. It is also called the RF attenuator. This is used to adjust the level of the signal incident upon the first mixer. This is important in order to prevent mixer gain compression and distortion due to high-level and/or broadband signals.

The **IF gain** is located after the mixer but before the IF, or RBW, filter. This is used to adjust the vertical position of signals on the display without affecting the signal level at the input mixer. When changed, the value of the reference level is changed accordingly. Since we do not want the reference level to change (i.e. the vertical position of displayed signals) when we change the input attenuator, these two components are tied together. The IF gain will automatically be changed to compensate for input attenuator changes, so signals remain stationary on the CRT display, and the reference level is not changed.

Spectrum Analysis Basics

Slide #15

Theory of Operation

How it all works together

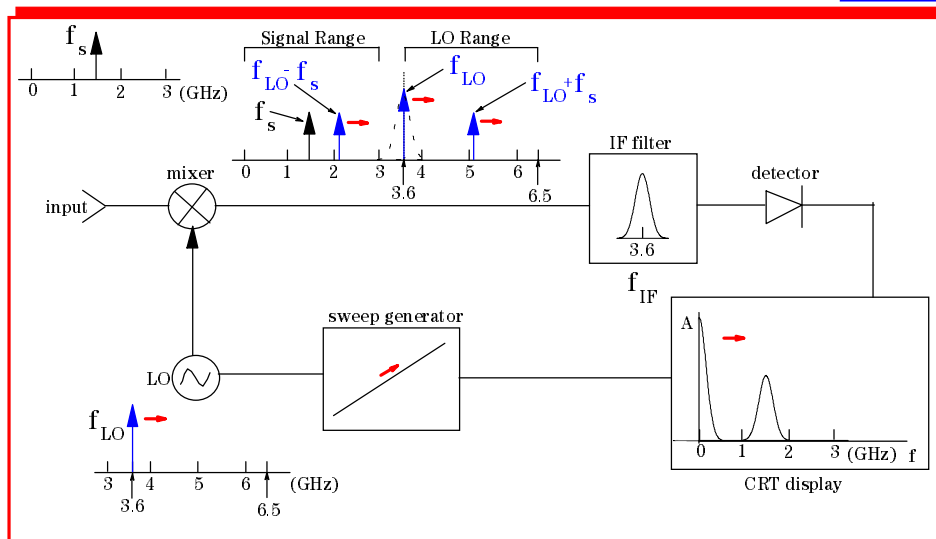

Let's see how these components work together to make a spectrum analyzer. Note that while the RF input attenuator, IF gain, and video filter are important components, they are not critical when describing how the analyzer works.

First of all, the signal to be analyzed is connected to the input of the spectrum analyzer. This input signal is then combined with the LO through the mixer, to convert (or translate) it to an intermediate frequency (IF). These signals are then sent to the IF filter. The output of this filter is detected, indicating the presence of a signal component at the analyzer's tuned frequency. The output voltage of the detector is used to drive the vertical axis (amplitude) of the analyzer display. The sweep generator provides synchronization between the horizontal axis of the display (frequency) and tuning of the LO. The resulting display shows amplitude versus frequency of spectral components of each incoming signal. Let's use the figure above to illustrate this point.

The horizontal arrows are intended to illustrate the "sweeping" of the analyzer. Starting with our LO at 3.6 GHz, the output of the mixer has four signals, one of which is at 3.6 GHz (f_{LO}). Notice that our IF filter is also at 3.6 GHz (it's shape has been imposed onto the frequency graph for clarity). Therefore, we expect to see this signal on the display. At 0 Hz on the CRT, we do indeed see a signal - this is called "LO Feedthrough". Now let's visualize our sweep generator moving to the right, causing our LO to sweep upward in frequency. As the LO sweeps, so too will three of the mixer output signals (the input signal is stationary). As our LO Feedthrough moves out of the IF filter bandwidth, we see it taper off on the display. As soon as our difference frequency ($f_{LO} - f_s$) comes into the skirt of the IF filter, we start to see it. When it is at the center (e.g. 3.6 GHz) we see the full amplitude of this signal on the display. And, as it moves further to the right, it leaves the filter skirt, and no signal is seen on the display.

So there it is. We've just seen our signal being swept through the fixed IF filter, and be properly displayed on the analyzer screen. That's how it works!

Spectrum Analysis Basics

Slide #16

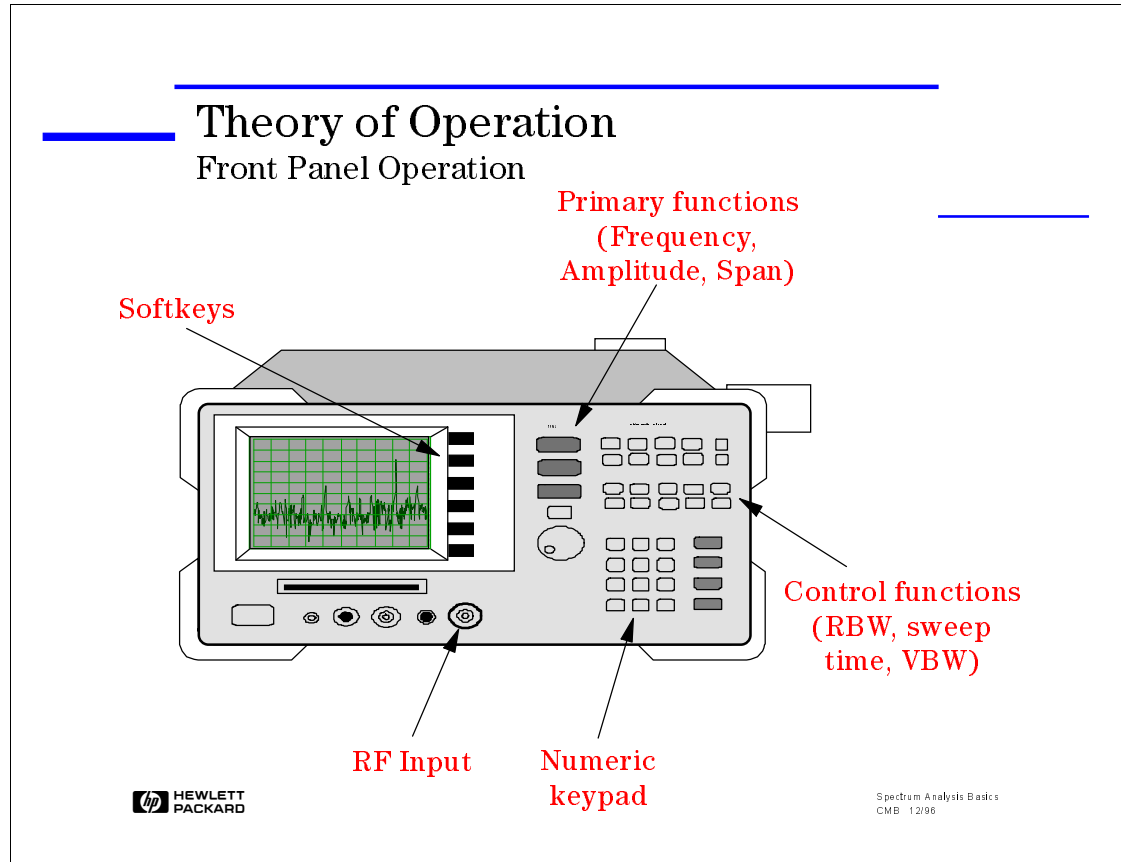

Before we move on, it's important to know what we can control on the analyzer via the front panel keys.

The three primary hardkeys on any spectrum analyzer are: frequency, amplitude, and span. Obviously, we need to be able to set up the analyzer for our particular measurement conditions. Frequency and amplitude are straightforward. Span is simply a way to tell the analyzer how big of a "window" in frequency we want to view.

Other important control functions include setting the resolution bandwidth, sweptime, input attenuator and video bandwidth. Modern analyzers have both hardkeys and softkeys (next to the CRT display). The softkeys allow you to access several different functions/features under one hardkey. For example, there will typically be a hardkey labeled "BW", which when pressed gives you the choice of changing either the RBW or the VBW depending upon which softkey you press.

Most analyzers allow you to enter values by either punching in the value on the number pad, or by "dialing" up or down to the desired value using the front panel knob.

Spectrum Analysis Basics

Slide #17

Agenda

- 
- Overview
 - Theory of Operation
 - **Specifications**
 - Features
 - Summary

Understanding the capabilities and limitations of a spectrum analyzer is a very important part of understanding spectrum analysis. Today's spectrum analyzers offer a great variety of features and levels of performance. Reading a datasheet can be very confusing. How do you know which specifications are important for your application and why?

Spectrum analyzer specifications are the instruments manufacturer's way of communicating the level of performance you can expect from a particular instrument. Understanding and interpreting these specifications enables you to predict how the analyzer will perform in a specific measurement situation.

We will now describe a variety of specifications that are important to understand.

Spectrum Analysis Basics

Slide #18

Specifications

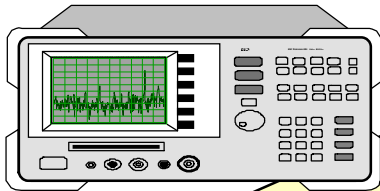

- ▶ Frequency Range
- ▶ Accuracy, Frequency & Amplitude
- ▶ Resolution
- ▶ Sensitivity
- ▶ Distortion
- ▶ Dynamic Range

What do you need to know about a spectrum analyzer in order to make sure you choose one that will make your particular measurements, and make them adequately? Very basically, you need to know 1) what's the frequency range? 2) what's the amplitude range (maximum input and sensitivity)? 3) to what level can I measure the difference between two signals, both in amplitude (dynamic range) and frequency (resolution)? and 4) how accurate are my measurements once I've made them?

Although not in the same order, we will describe each of these areas in detail in terms of what they mean and why they are important.

Spectrum Analysis Basics

Slide #19

Specifications

Frequency Range

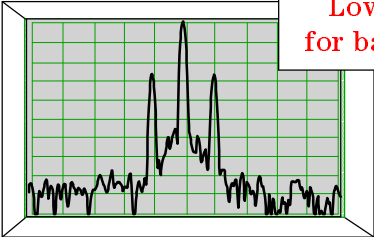

Low frequencies
for baseband and IF

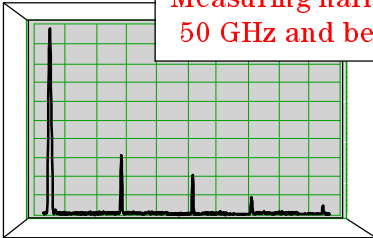

Measuring harmonics
50 GHz and beyond!



Spectrum Analysis Basics
CMB 12/96

Of course, the first and foremost specification you want to know is the **frequency range** of the analyzer. Not only do you want a spectrum analyzer that will cover the fundamental frequencies of your application, but don't forget harmonics or spurious signals on the high end, or baseband and IF on the low end.

An example of needing higher frequency capability is in wireless communications. Some of the cellular standards require that you measure out to the tenth harmonic of your system. If you're working at 900 MHz, that means you need an analyzer that has a high frequency of $10 * 900 \text{ MHz} = 9 \text{ GHz}$. Also, although we are talking about RF analyzers, you want it to be able to measure your lower frequency baseband and IF signals as well.

Spectrum Analysis Basics

Slide #20

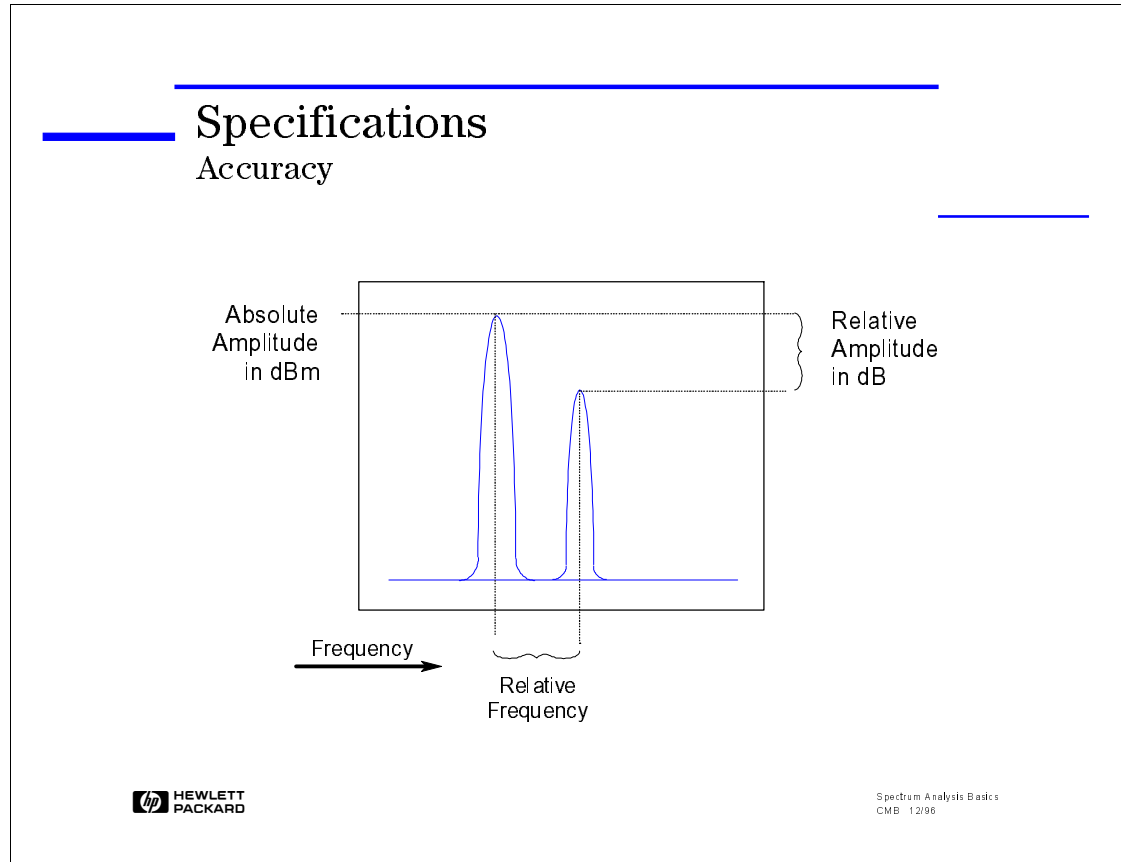

The second area to understand is **accuracy**; how accurate will my results be in both frequency and amplitude? When talking about accuracy specifications, it is important to understand that there is both an absolute accuracy specification, and a relative accuracy specification.

The absolute measurement is made with a single marker. For example, the frequency and power level of a carrier for distortion measurements is an absolute measurement.

The relative measurement is made with the relative, or delta, marker. Examples include modulation frequencies, channel spacing, pulse repetition frequencies, and offset frequencies relative to the carrier. Relative measurements are more accurate than absolute measurements.

Let's begin by discussing frequency accuracy.

Spectrum Analysis Basics

Slide #21

Specifications

Accuracy: Frequency Readout Accuracy

Typical datasheet specification:

Spans < 2 MHz: \pm (freq. readout x freq. ref. accuracy
+ 1% of frequency span
+ 15% of resolution bandwidth
+ 10 Hz "residual error")

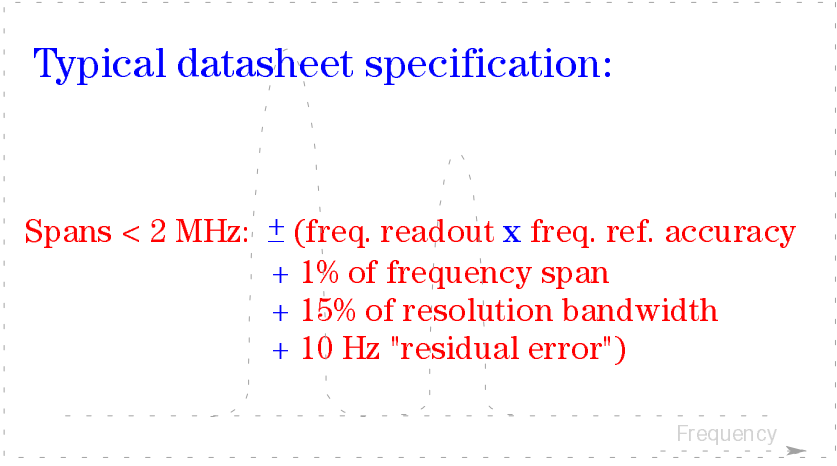



Spectrum Analysis Basics
CMB 12/96

Frequency accuracy is often listed under the Frequency Readout Accuracy specification and is usually specified as the sum of several sources of errors, including frequency-reference inaccuracy, span error, and RBW center-frequency error.

Frequency-reference accuracy is determined by the basic architecture of the analyzer. The quality of the instrument's internal timebase is also a factor, however, many spectrum analyzers use an ovenized, high-performance crystal oscillator as a standard or optional component, so this term is small.

There are two major design categories of modern spectrum analyzers: synthesized and free-running. In a synthesized analyzer, some or all of the oscillators are phase-locked to a single, traceable, reference oscillator. These analyzers have typical accuracy's on the order of a few hundred hertz. This design method provides the ultimate in performance with according complexity and cost. Spectrum analyzers employing a free-running architecture use a simpler design and offer moderate frequency accuracy at an economical price. Free-running analyzers offer typical accuracy's of a few megahertz. This may not be a hindrance in many cases. For example, many times we are measuring an isolated signal, or we need just enough accuracy to be able to identify the signal of interest among other signals.

Span error is often split into two specs, based on the fact that many spectrum analyzers are fully synthesized for small spans, but are open-loop tuned for larger spans. (The slide shows only one span specification.)

RBW error can be appreciable in some spectrum analyzers, especially for larger RBW settings, but in most cases it is much smaller than the span error.

Spectrum Analysis Basics

Slide #22

Specifications

Accuracy: Frequency Readout Accuracy Example

Single Marker Example:

2 GHz
400 kHz span
3 kHz RBW

Calculation: $(2 \times 10^9 \text{ Hz}) \times (1.3 \times 10^{-7} / \text{yr. ref. error}) = 260 \text{ Hz}$
 1% of 400 kHz span = 4000 Hz
 15% of 3 kHz RBW = 450 Hz
 10 Hz residual error = 10 Hz
 Total = $\pm 4720 \text{ Hz}$

Let's use the previous equation in an example to illustrate how you can calculate the frequency accuracy of your measurement.

If we're measuring a signal at 2 GHz, using a 400 kHz span and a 3 kHz RBW, we can determine our frequency accuracy as follows:

Frequency reference accuracy is calculated by adding up the sources of error shown (all of which can be found on the datasheet):

$$\begin{aligned} \text{freq ref accuracy} &= 1.0 \times 10^{-7} (\text{aging}) + 0.1 \times 10^{-7} (\text{temp stability}) + 0.1 \times 10^{-7} (\text{setability}) \\ &+ 0.1 \times 10^{-7} (15 \text{ warm-up}) = 1.3 \times 10^{-7} / \text{yr. ref error} \end{aligned}$$

Therefore, our frequency accuracy is:

$$\begin{aligned} (2 \times 10^9 \text{ Hz}) \times (1.3 \times 10^{-7} / \text{yr}) &= 260 \text{ Hz} \\ 1\% \text{ of } 400 \text{ kHz span} &= 4000 \text{ Hz} \\ 15\% \text{ of } 3 \text{ kHz RBW} &= 450 \text{ Hz} \\ 10 \text{ Hz residual error} &= 10 \text{ Hz} \\ \hline \text{Total} &= \pm 4720 \text{ Hz} \end{aligned}$$

Spectrum Analysis Basics

Slide #23

Specifications

Accuracy: Relative Amplitude Accuracy

- **Display fidelity**
- **Frequency response**
- **Δ RF Input attenuator**
- **Δ Reference level**
- **Δ Resolution bandwidth**
- **Δ CRT scaling**

Relative
Amplitude
in dB

Let's now discuss *amplitude accuracy*.

Most spectrum analyzers are specified in terms of both absolute and relative amplitude accuracy. Since the relative performance of the analyzer affects both types of accuracy, we will discuss this first.

When we make relative measurements on an incoming signal, we use some part of the signal as a reference. For example, when we make second-harmonic distortion measurements, we use the fundamental of the signal as our reference. Absolute values do not come into play; we are interested only in how the second harmonic differs in amplitude from the fundamental.

Relative amplitude accuracy depends upon such items as shown above. Display fidelity and frequency response will directly affect the amplitude accuracy. The other four items, on the other hand, involve control changes made during the course of a measurement, and therefore affect accuracy only when changed. In other words, if only the frequency control is changed when making the relative measurement, these four uncertainties drop out. If they are changed, however, their uncertainties will further degrade accuracy.

Spectrum Analysis Basics

Slide #24

Specifications

Accuracy: Relative Amplitude Accuracy - Display Fidelity

- Applies when signals are not placed at the same reference amplitude
- Display fidelity includes
 - Log amplifier or linear fidelity
 - Detector linearity
 - Digitizing circuit linearity
- Technique for best accuracy

Relative
Amplitude
in dB

Display fidelity covers a variety of factors. Among them are the log amplifier (how true the logarithmic characteristic is), the detector (how linear), and the digitizing circuits (how linear). The CRT itself is not a factor for those analyzers using digital techniques and offering digital markers because the marker information is taken from trace memory, not the CRT. The display fidelity is better over small amplitude differences, and ranges from a few tenths of a dB for signal levels close together to perhaps 2 dB for large amplitude differences.

A technique for improving amplitude accuracy is to place the first signal at a reference amplitude using the reference level control, and use the marker to read amplitude value. Then move the second signal to the same reference and calculate the difference. This assumes that the Reference Level Uncertainty (changing the reference level) is less than the Display Fidelity Uncertainty.

Spectrum Analysis Basics

Slide #25

Specifications

Accuracy: Relative Amplitude Accuracy - Freq. Response

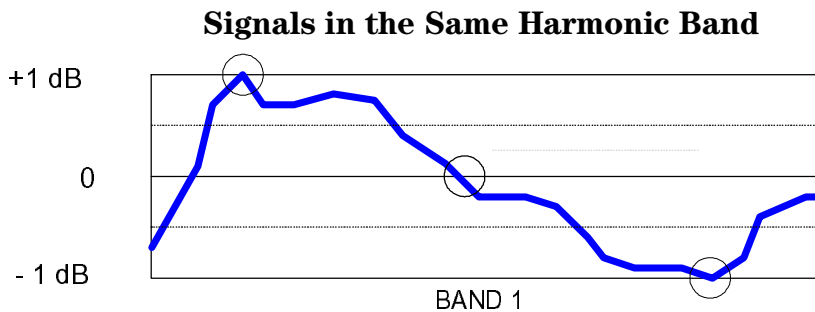

Specification: ± 1 dB

The frequency response, or flatness of the spectrum analyzer, also plays a part in relative amplitude uncertainties and is frequency-range dependent. A low-frequency RF analyzer might have a frequency response of ± 0.5 dB. On the other hand, a microwave spectrum analyzer tuning in the 20 GHz range could well have a frequency response in excess of ± 4 dB.

The specification assumes the worst case situation, where frequency response varies the full amplitude range, in this case plus 1 dB and minus 1 dB. The uncertainty between two signals in the same band (the spectrum analyzer's frequency range is actually split into several bands) is $2 \times \pm 1 \text{ dB} = \pm 2 \text{ dB}$ since the amplitude uncertainty at each signal's position could fall on the + and - extremes of the specification window.

Spectrum Analysis Basics

Slide #26

Specifications

Accuracy: Relative Amplitude Accuracy

- **Δ RF Input attenuator**
- **Δ Reference level**
- **Δ Resolution bandwidth**
- **Δ CRT scaling**

Relative
Amplitude
in dB



Spectrum Analysis Basics
CMB 12/96

As we mentioned before, the four items listed above involve control changes made during the course of a measurement, and can be eliminated if they can be left unchanged.

Because an RF input attenuator must operate over the entire frequency range of the analyzer, its step accuracy, like frequency response, is a function of frequency. At low RF frequencies, we expect the attenuator to be quite good; at 20 GHz, not as good.

The IF gain (or reference level control) has uncertainties as well, but should be more accurate than the input attenuator because it operates at only one frequency.

Since different filters have different insertion losses, changing the RBW can also degrade accuracy.

Finally, changing display scaling from say, 10 dB/div to 1 dB/div or to linear may also introduce uncertainty in the amplitude measurement.

Spectrum Analysis Basics

Slide #27

Specifications

Accuracy: Absolute Amplitude Accuracy

Absolute Amplitude in dBm

- **Calibrator accuracy**
- **Frequency response**
- **Reference level uncertainty**

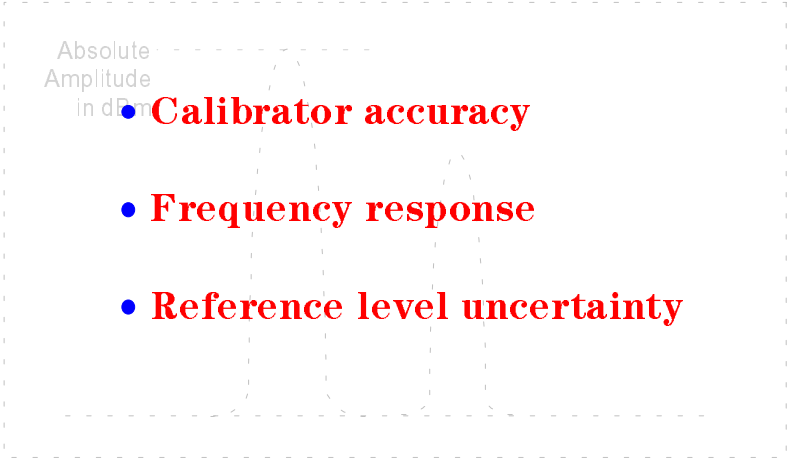

Spectrum Analysis Basics
CMB 12/96

Absolute amplitude measurements are actually measurements that are relative to the calibrator, which is a signal of known amplitude. Most modern spectrum analyzers have a calibrator built inside. This calibrator provides a signal with a specified amplitude at a given frequency. Since this calibrator source typically operates on a single frequency, we rely upon the relative accuracy of the analyzer to extend absolute calibration to other frequencies and amplitudes. A typical calibrator has an uncertainty of ± 0.3 dB. For log displays, the top line of the graticule (Reference Level) is given absolute calibration. Other points of the display are relative to that level.

Since our unknown signal to be measured is at a different frequency, we must change the frequency control. Since it is at a different amplitude, we may change reference level to bring it to the reference level, for best accuracy. Hence, absolute amplitude accuracy depends on calibrator accuracy, frequency response, and reference level uncertainty (also known as IF gain uncertainty).

Spectrum Analysis Basics

Slide #28

Specifications

Accuracy: Other Sources of Uncertainty

- **Mismatch** (RF input port not exactly 50 ohms)
- **Compression due to overload** (high-level input signal)
- **Distortion products**
- **Amplitudes below the log amplifier range**
- **Signals near noise**
- **Noise causing amplitude variations**
- **Two signals incompletely resolved**

This is a list of other sources of uncertainty that you should be aware of, some of which are due to the specific measurement and not the analyzer itself.

If we step back and take a look at all of the uncertainties we've mentioned and how they contribute to the inaccuracy of the measurement, we might well be concerned. And even though we tell ourselves that these are worst-case values and that almost never are all factors at their worst and in the same direction at the same time, still we must add the figures directly if we are to certify the accuracy of a specific measurement.

There are some things that you can do to improve the situation. First of all, you should know the specifications for your particular spectrum analyzer. These specs may be good enough over the range in which you are making your measurement. Also, before taking any data, you can step through a measurement to see if any controls can be left unchanged. If so, all uncertainties associated with changing these controls drop out. You may be able to trade off reference level against display fidelity, using whichever is more accurate and eliminating the other as an uncertainty factor. If you have a more accurate calibrator, or one closer to the frequency of interest, you may wish to use that in lieu of the built-in calibrator.

And finally, most analyzers available today have self-calibration routines which may be manual or automatic. These routines generate error-coefficients (for example, amplitude changes versus resolution bandwidth) that the analyzer uses later to correct measured data. As a result, these self-calibration routines allow us to make good amplitude measurements with a spectrum analyzer and give us more freedom to change controls during the course of a measurement.

Spectrum Analysis Basics

Slide #29

Specifications Resolution

What Determines Resolution?

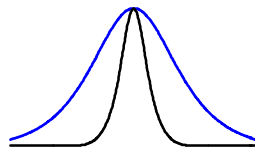

Resolution
Bandwidth



Residual FM

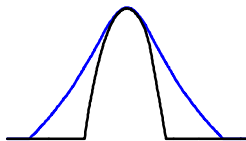

RES BW Type
and Selectivity

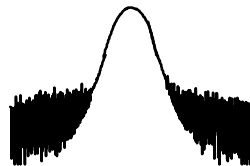

Noise Sidebands

Resolution is an important specification when you are trying to measure signals that are close together and want to be able to distinguish them from each other. We saw that the IF filter bandwidth is also known as the resolution bandwidth (RBW). This is because it is the IF filter bandwidth and shape that determines the resolvability between signals.

In addition to filter bandwidth, the selectivity, filter type, residual FM, and noise sidebands are factors to consider in determining useful resolution. We shall examine each of these in turn.

Spectrum Analysis Basics

Slide #30

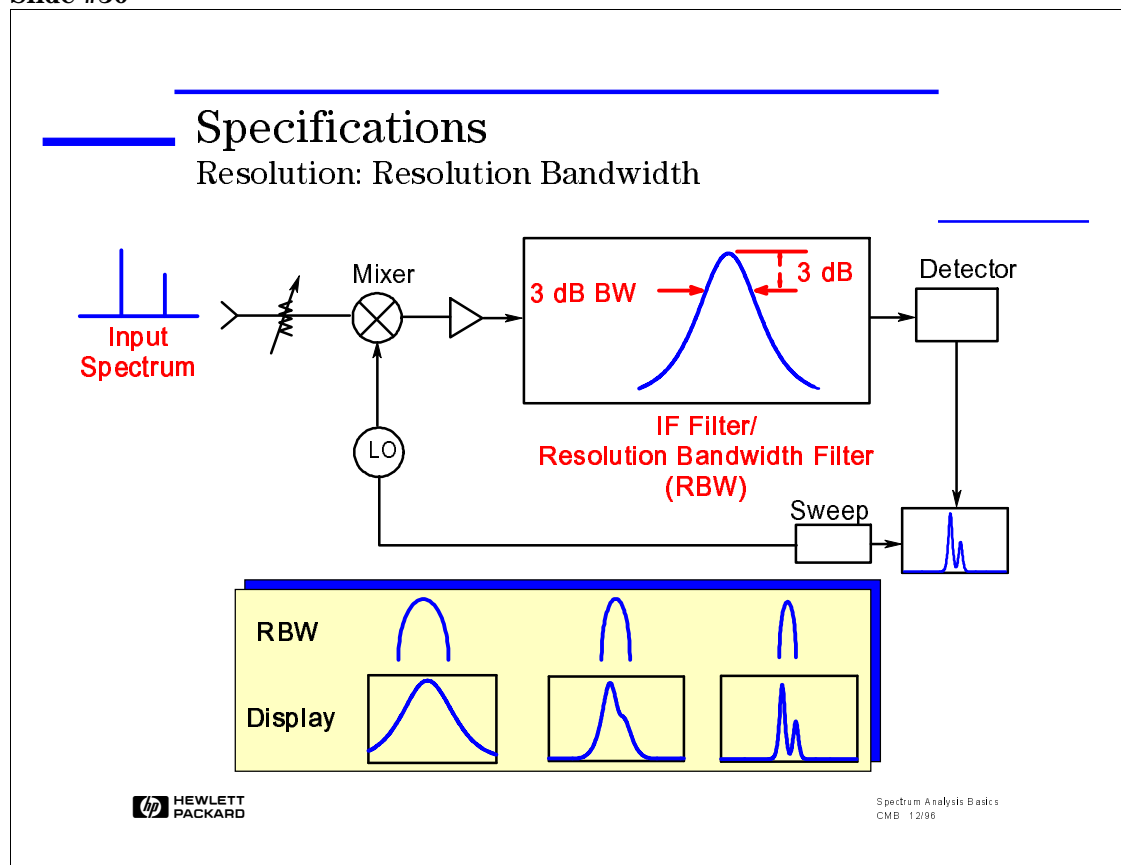

One of the first things to note is that a signal cannot be displayed as an infinitely narrow line. It has some width associated with it. This shape is the analyzer's tracing of its own IF filter shape as it tunes past a signal. Thus, if we change the filter bandwidth, we change the width of the displayed response. HP datasheets specify the 3 dB bandwidth. Some other manufacturers specify the 6 dB bandwidth.

This concept enforces the idea that it is the IF filter bandwidth and shape that determines the resolvability between signals.

Spectrum Analysis Basics

Slide #31

Specifications

Resolution: Resolution Bandwidth

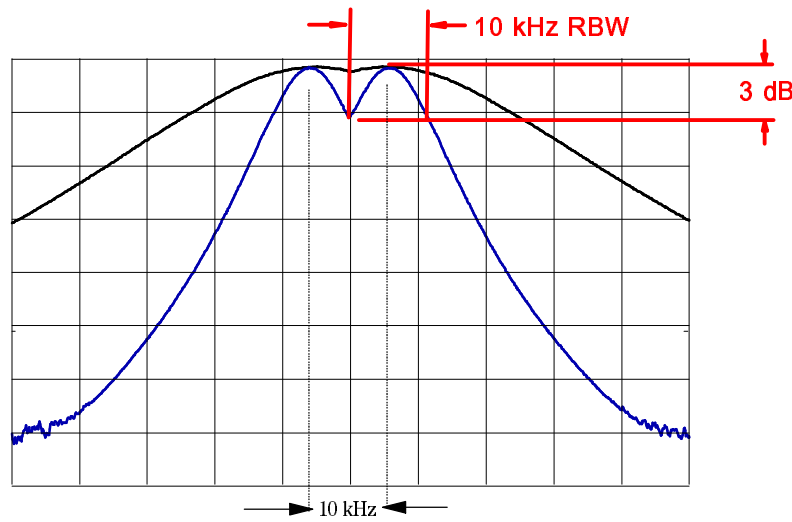

When measuring two signals of equal-amplitude, the value of the selected RBW tells us how close together they can be and still be distinguishable from one another (by a 3 dB 'dip'). For example, if two signals are 10 kHz apart, a 10 kHz RBW easily separates the responses. However, with wider RBWs, the two signals may appear as one.

In general then, two equal-amplitude signals can be resolved if their separation is greater than or equal to the 3 dB bandwidth of the selected resolution bandwidth filter.

NOTE: Since the two signals interact when both are present within the RBW, you should use a Video BW about 10 times smaller than the Res BW to smooth the responses.

Spectrum Analysis Basics

Slide #32

Specifications

Resolution: RBW Type and Selectivity

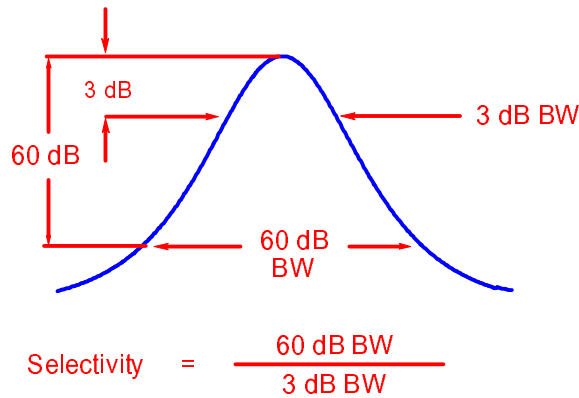

Selectivity is the important characteristic for determining the resolvability of *unequal* amplitude signals. Selectivity is the ratio of the 60 dB to 3 dB filter bandwidth. Typical selectivities range from 11:1 to 15:1 for analog filters, and 5:1 for digital filters.

Usually we will be looking at signals of unequal amplitudes. Since both signals will trace out the filter shape, it is possible for the smaller signal to be buried under the filter skirt of the larger one. The greater the amplitude difference, the more a lower signal gets buried under the skirt of its neighbor's response. This is significant, because most close-in signals you deal with are distortion or modulation products and, by nature, are quite different in amplitude from the parent signal.

Spectrum Analysis Basics

Slide #33

Specifications

Resolution: RBW Type and Selectivity

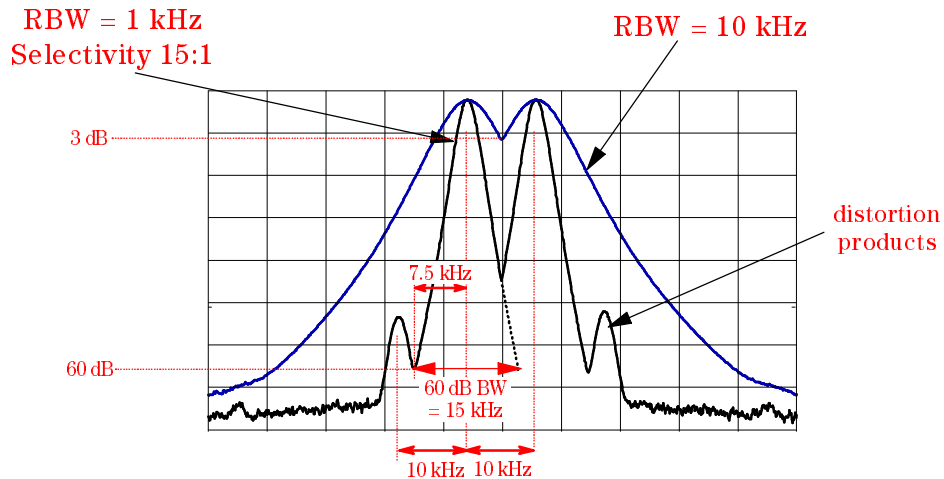

For example, say we are doing a two-tone test where the signals are separated by 10 kHz. With a 10 kHz RBW, resolution of the equal amplitude tones is not a problem, as we have seen. But the distortion products, which can be 50 dB down and 10 kHz away, could be buried.

Let's try a 3 kHz RBW which has a selectivity of 15:1. The filter width 60 dB down is 45 kHz (15 x 3 kHz), and therefore, distortion will be hidden under the skirt of the response of the test tone. If we switch to a narrower filter (for example, a 1 kHz filter) the 60 dB bandwidth is 15 kHz (15 x 1 kHz), and the distortion products are easily visible (because one-half of the 60 dB bandwidth is 7.5 kHz, which is less than the separation of the sidebands). So our required RBW for the measurement must be ≤ 1 kHz.

This tells us then, that two signals unequal in amplitude by 60 dB must be separated by at least one half the 60 dB bandwidth to resolve the smaller signal. Hence, selectivity is key in determining the resolution of unequal amplitude signals.

Spectrum Analysis Basics

Slide #34

Specifications

Resolution: Residual FM

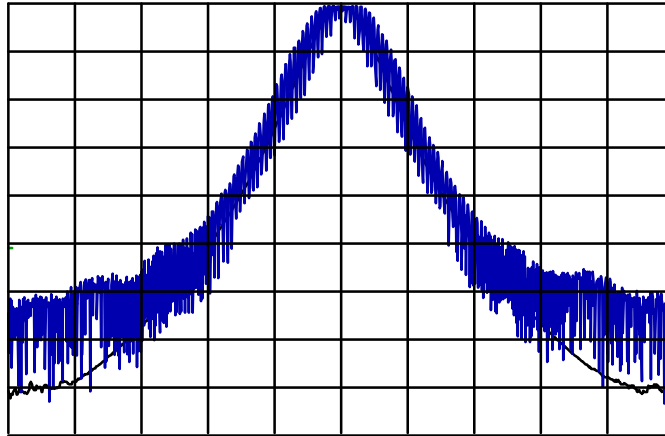

**Residual FM
"Smears" the Signal**

Another factor affecting resolution is the frequency stability of the spectrum analyzer's local oscillator. This inherent short-term frequency instability of an oscillator is referred to as residual FM. If the spectrum analyzer's RBW is less than the peak-to-peak FM, then this residual FM can be seen and looks as if the signal has been "smeared". You cannot tell whether the signal or the LO is the source of the instability. Also, this "smearing" of the signal makes it so that two signals within the specified residual FM cannot be resolved.

This means that the spectrum analyzer's residual FM dictates the *minimum resolution bandwidth* allowable, which in turn determines the minimum spacing of equal amplitude signals.

Phase locking the LOs to a reference reduces the residual FM and reduces the minimum allowable RBW. Higher performance spectrum analyzers are more expensive because they have better phase locking schemes with lower residual FM and smaller minimum RBWs.

Spectrum Analysis Basics

Slide #35

Specifications

Resolution: Noise Sidebands

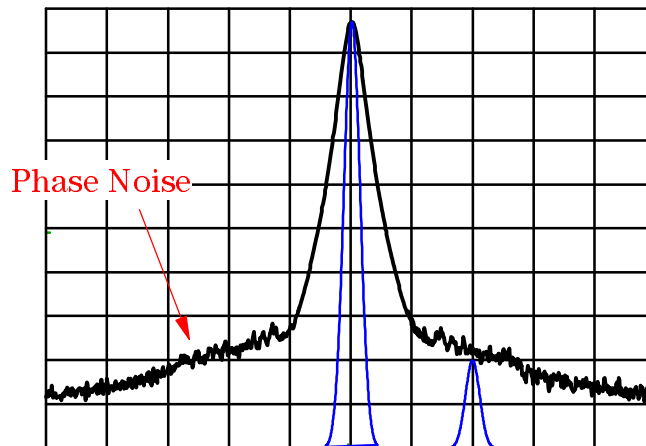

Noise Sidebands can prevent resolution of unequal signals

The remaining instability appears as *noise sidebands* (also called *phase noise*) at the base of the signal response. This noise can mask close-in (to a carrier), low-level signals that we might otherwise be able to see if we were only to consider bandwidth and selectivity. These noise sidebands affect resolution of close-in, low-level signals.

Phase noise is specified in terms of dBc or dB relative to a carrier and is displayed only when the signal is far enough above the system noise floor. This becomes the ultimate limitation in an analyzer's ability to resolve signals of unequal amplitude. The above figure shows us that although we may have determined that we should be able to resolve two signals based on the 3-dB bandwidth and selectivity, we find that the phase noise actually covers up the smaller signal.

Noise sideband specifications are typically normalized to a 1 Hz RBW. Therefore, if we need to measure a signal 50 dB down from a carrier at a 10 kHz offset in a 1 kHz RBW, we need a phase noise spec of ≤ -80 dBc/1Hz RBW at 10 kHz offset. Note: 50 dBc in a 1 kHz RBW can be normalized to a 1 Hz RBW using the following equation. $(-50 \text{ dBc} - [10 \cdot \log(1\text{kHz}/1\text{Hz})]) = (-50 - [30]) = -80 \text{ dBc}$.

Spectrum Analysis Basics

Slide #36

Specifications

Resolution: RBW Determines Measurement Time

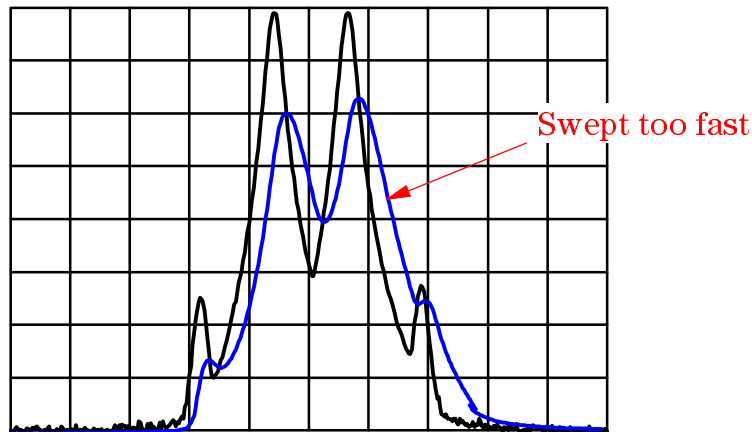

**Penalty For Sweeping Too Fast
Is An Uncalibrated Display**

When we narrow the resolution bandwidths for better resolution, we must consider the time it takes to sweep through them. Since these filters are bandwidth limited, they require a finite time to respond fully. Narrower bandwidths require a longer time. When the sweep time is too short, the RBW filters cannot fully respond, and the displayed response becomes uncalibrated both in amplitude and frequency - the amplitude is too low and the frequency is too high (shifts upwards) due to delay through the filter.

Spectrum analyzers have *auto-coupled sweep time* which automatically chooses the fastest allowable sweep time based upon selected Span, RBW, and VBW. If the sweep time manually chosen is too fast, a message is displayed on the screen.

Spectrum analyzers usually have a 1-10 or a 1-3-10 sequence of RBWs, some even have 10% steps. More RBWs are better because this allows choosing just enough resolution to make the measurement at the fastest possible sweep time. For example, if 1 kHz resolution (1 sec sweep time) is not enough resolution, a 1-3-10 sequence analyzer can make the measurement in a 300 Hz Res BW (10 sec sweep time), whereas the 1-10 sequence analyzer must use a 100 Hz Res BW (100 sec sweep time)!

Spectrum Analysis Basics

Slide #37

Specifications

Resolution: Digital Resolution Bandwidths

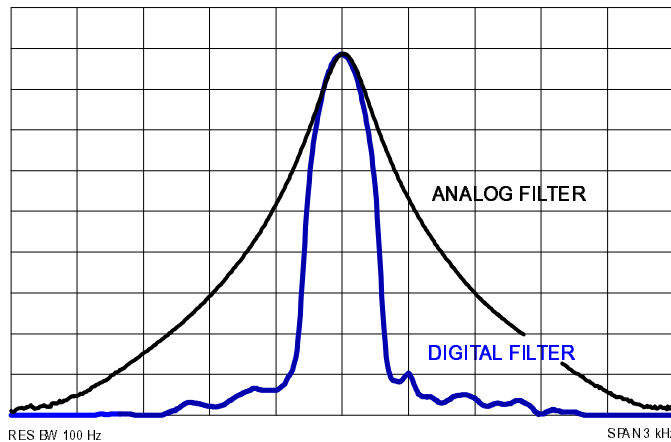

Typical Selectivity

Analog 15:1
Digital 5:1

One thing to note before we close the topic of resolution is that Digital RBWs (i.e. spectrum analyzers using digital signal processing (DSP) based IF filters) have superior selectivity and measurement speed. The following table illustrates this point. For example, with a 100 Hz RBW, a digital filter is 3.1 times faster than an analog.

RBW	Speed Improvement
100 Hz	3.1
30 Hz	14.4
10 Hz	52.4
3 Hz	118
1 Hz	84

Spectrum Analysis Basics

Slide #38

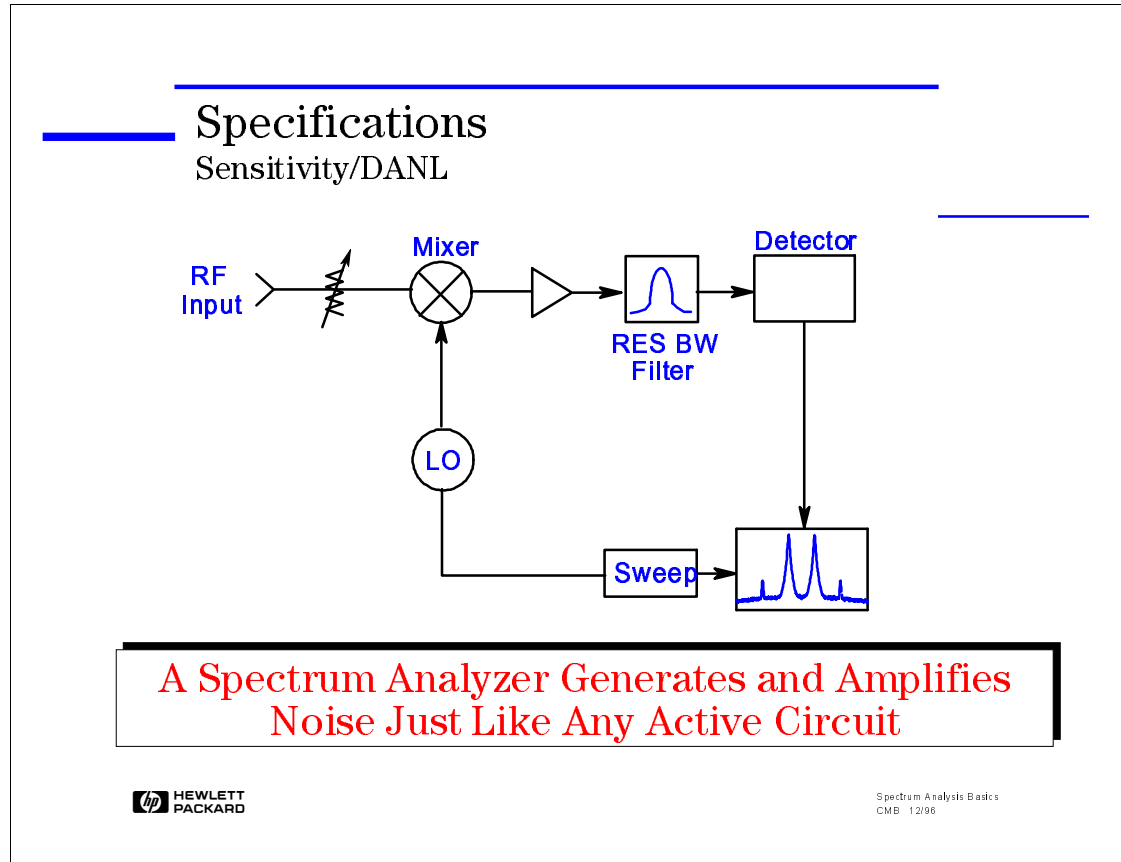

One of the primary uses of a spectrum analyzer is to search out and measure low-level signals. The **sensitivity** of any receiver is an indication of how well it can measure small signals. A perfect receiver would add no additional noise to the natural amount of thermal noise present in all electronic systems, represented by kTB (k =Boltzman's constant, T =temperature, and B =bandwidth). In practice, all receivers, including spectrum analyzers, add some amount of internally generated noise.

Spectrum analyzers usually characterize this by specifying the displayed average noise level (DANL) in dBm, with the smallest RBW setting. DANL is just another term for the noise floor of the instrument given a particular bandwidth. It represents the best-case sensitivity of the spectrum analyzer, and is the ultimate limitation in making measurements on small signals. An input signal below this noise level cannot be detected. Generally, sensitivity is on the order of -90 dBm to -145 dBm.

It is important to know the sensitivity capability of your analyzer in order to determine if it will adequately measure your low-level signals.

Spectrum Analysis Basics

Slide #39

Specifications

Sensitivity/DANL: RF Input Attenuator

Effective Level of Displayed Noise is a Function of RF Input Attenuation

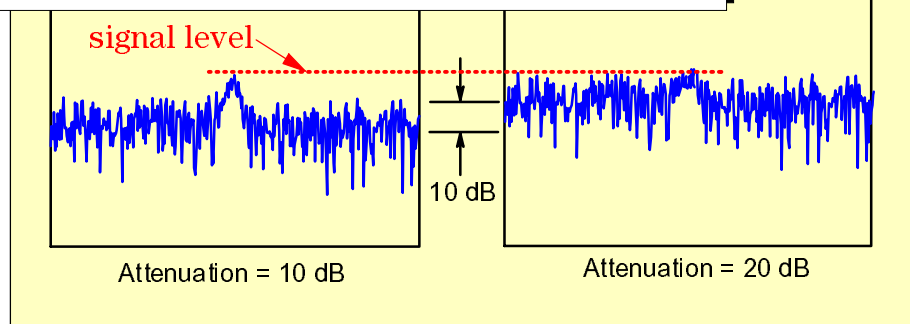

Signal-To-Noise Ratio Decreases as RF Input Attenuation is Increased

One aspect of the analyzer's internal noise that is often overlooked is its effective level as a function of the RF input attenuator setting. Since the internal noise is generated after the mixer (primarily in the first active IF stage), the RF input attenuator has no effect on the actual noise level. (Refer to the block diagram). However, the RF input attenuator does affect the signal level at the input and therefore decreases the signal-to-noise ratio (SNR) of the analyzer. The best SNR is with the lowest possible RF input attenuation.

Note in the figure, that the displayed signal level does not fall with increased attenuation. Remember from the theory of operation section that the RF input attenuator and IF gain are tied together. Therefore, as we increase the RF input attenuation 10 dB, the IF gain will simultaneously increase 10 dB to compensate for the loss. The result is that the on-screen signal stays constant, but the (amplified) noise level increases 10 dB.

Spectrum Analysis Basics

Slide #40

Specifications

Sensitivity/DANL: IF Filter (RBW)

Displayed Noise is a Function of
IF Filter Bandwidth

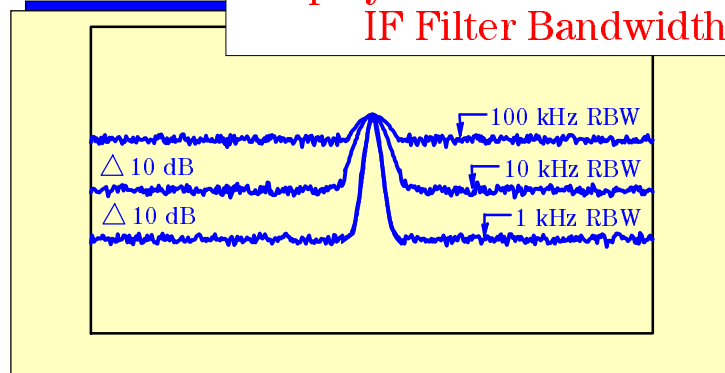

Decreased BW = Decreased Noise

This internally generated noise in a spectrum analyzer is thermal in nature; that is, it is random and has no discrete spectral components. Also, its level is flat over a frequency range that is wide in comparison to the ranges of the RBWs. This means that the total noise reaching the detector (and displayed) is related to the RBW selected. Since the noise is random, it is added on a power basis, so the relationship between displayed noise level and RBW is a ten log basis. In other words, if the RBW is increased (or decreased) by a factor of ten, ten times more (or less) noise energy hits the detector and the displayed average noise level (DANL) increases (or decreases) by 10 dB.

The relationship between displayed noise level and RBW is:

$$\text{noise level change (dB)} = 10 \log(\text{RBW}_{\text{new}}/\text{RBW}_{\text{old}})$$

Therefore, changing the RBW from 100 kHz (RBW_{old}) to 10 kHz (RBW_{new}) results in a change of noise level:

$$\text{noise level change} = 10 \log(10 \text{ kHz}/100 \text{ kHz}) = -10 \text{ dB.}$$

Spectrum analyzer noise is specified in a specific RBW. The spectrum analyzer's lowest noise level (and slowest sweep time) is achieved with its narrowest RBW.

Spectrum Analysis Basics

Slide #41

Specifications

Sensitivity/DANL: VBW

Video BW Smooths Noise for Easier
Identification of Low Level Signals

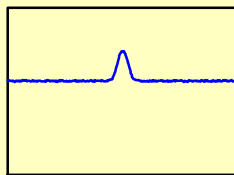
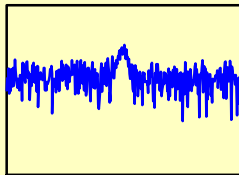

In the Theory of Operation section, we learned how the video filter can be used to smooth noise for easier identification of low level signals. Since we are talking about measuring low level signals, we will repeat it here. The VBW, however, does not effect the frequency resolution of the analyzer (as does the RBW), and therefore changing the VBW *does not improve sensitivity*. It does, however, improve discernability and repeatability of low signal-to-noise ratio measurements.

Spectrum Analysis Basics

Slide #42

Specifications

Sensitivity/DANL

Sensitivity is the Smallest Signal That
Can Be Measured

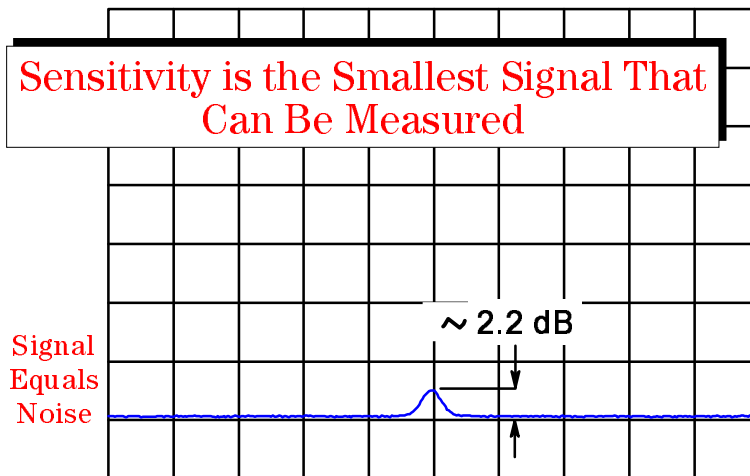

A signal whose level is equal to the displayed average noise level (DANL) will appear approximately as a 2.2 dB bump above the displayed average noise level. This is considered to be the minimum measurable signal level. However, you won't be able to see this signal unless you use video filtering to average the noise.

Spectrum analyzer sensitivity is specified as the DANL in a specified RBW.

Spectrum Analysis Basics

Slide #43

Specifications Sensitivity/DANL

For Best Sensitivity Use:

- ★ **Narrowest Resolution BW**
- ★ **Minimum RF Input Attenuation**
- ★ **Sufficient Video Filtering
(Video BW < .01 Res BW)**

Based on what we've learned, we can see that the best sensitivity is achieved at:

1. narrowest RBW
2. minimum RF Input Attenuation
3. using sufficient Video Filtering
(VBW \leq 0.1 to 0.01 RBW)

Note however, that best sensitivity may conflict with other measurement requirements. For example, smaller RBWs greatly increase measurement time. Also, zero dB input attenuation increases mismatch uncertainty therefore decreasing measurement accuracy.

Spectrum Analysis Basics

Slide #44

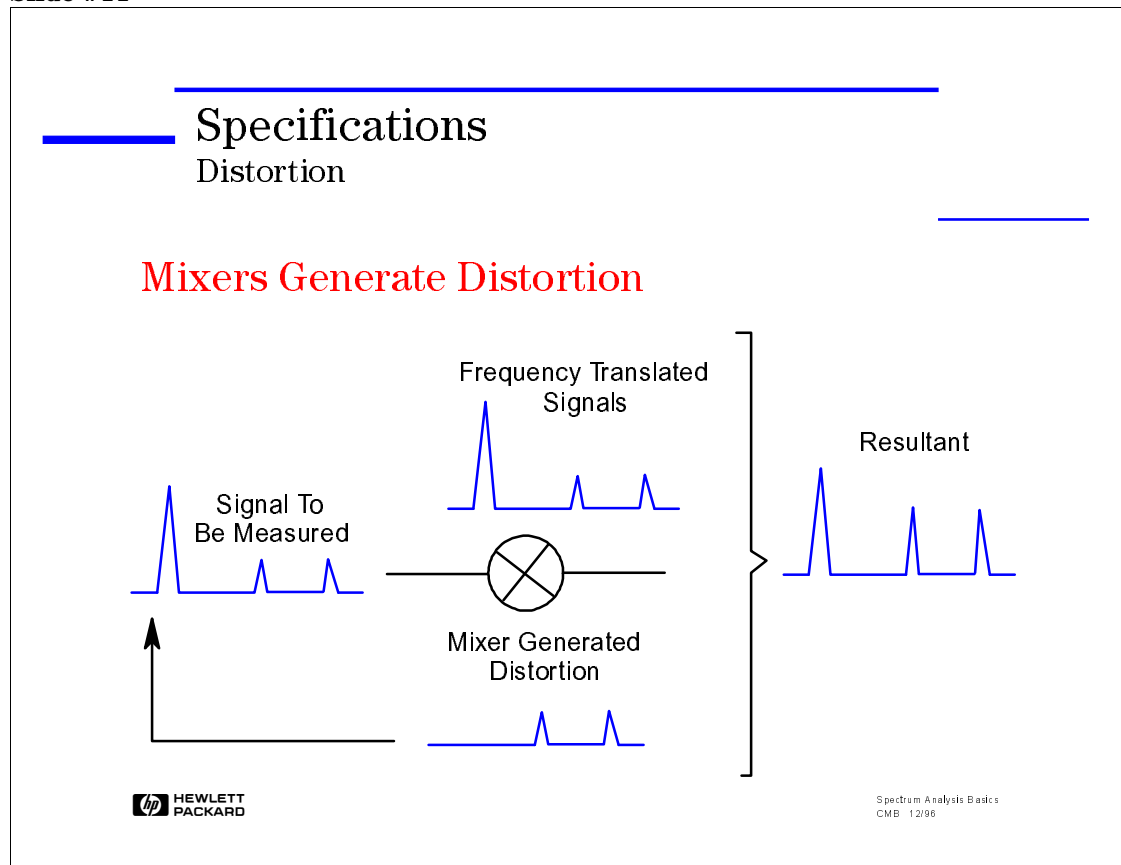

Although distortion measurements, such as third order intermodulation and harmonic distortion, are common measurements for characterizing devices, the spectrum analyzer itself will also produce distortion products, and potentially disturb your measurement.

The **distortion** performance of the analyzer is specified by the manufacturer, either directly or lumped into a dynamic range specification, as we will see shortly.

Because mixers are non-linear devices, they will generate internal distortion. This internal distortion can, at worst, completely cover up the external distortion products of the device. But even when the internal distortion is below the distortion we are trying to measure, internal distortion often causes errors in the measurement of the (external) distortion of the DUT.

As we will see, the internally generated distortion is a function of the input power, therefore, there is no single distortion specification for a spectrum analyzer. We need to understand how distortion is related to the input signal, so that we can determine for our particular application, whether or not the distortion caused by the analyzer, will effect our measurement.

Spectrum Analysis Basics

Slide #45

Specifications Distortion

Most Influential Distortion is the
Second and Third Order

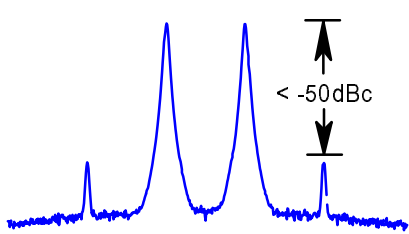

Two-Toned Intermod

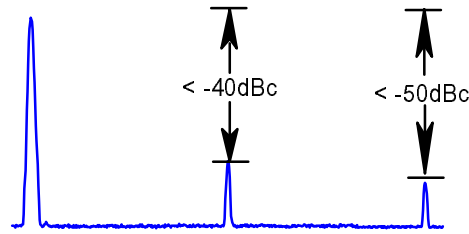

Harmonic Distortion

The critical question is, how much internal distortion is too much? The measurement itself determines how much distortion is too much. If the test itself specified that you must be able to view say, two-tone distortion products (third order products) more than 50 dB and second order (harmonic) distortion more than 40 dB below the fundamental, then this would set the minimum levels necessary for the analyzer specifications. To reduce measurement error caused by the presence of internal distortion, the internal distortion must actually be much lower than the test specifications.

Spectrum Analysis Basics

Slide #46

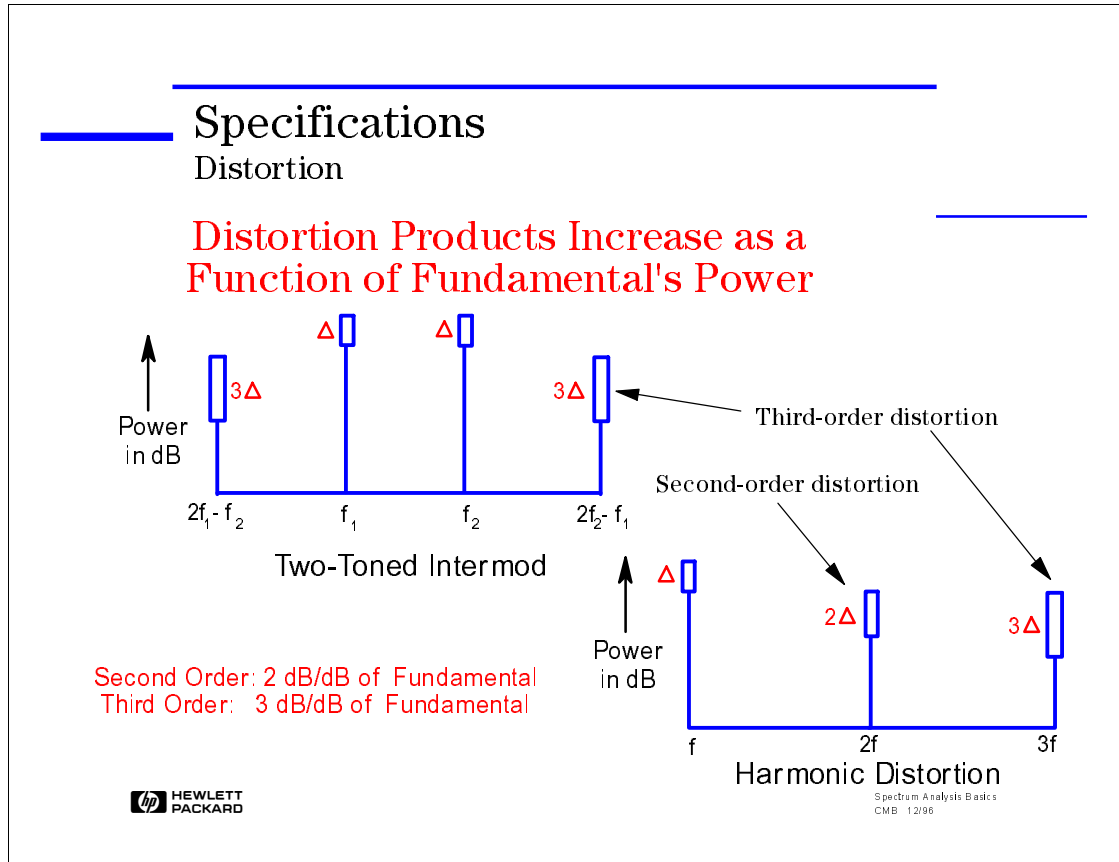

The behavior of distortion for any nonlinear device, whether it be the internally generated distortion of the spectrum analyzer's first mixer or the distortion generated by your device under test is shown in the slide. The second-order distortion increases as a square of the fundamental, and the third-order distortion increases as a cube. This means that on the log scale of our spectrum analyzer, the level of the second-order distortion will change twice as fast as the fundamental, and the third-order distortion will change three times as fast.

Spectrum Analysis Basics

Slide #47

Specifications

Distortion

Relative Amplitude Distortion Changes
with Input Power Level

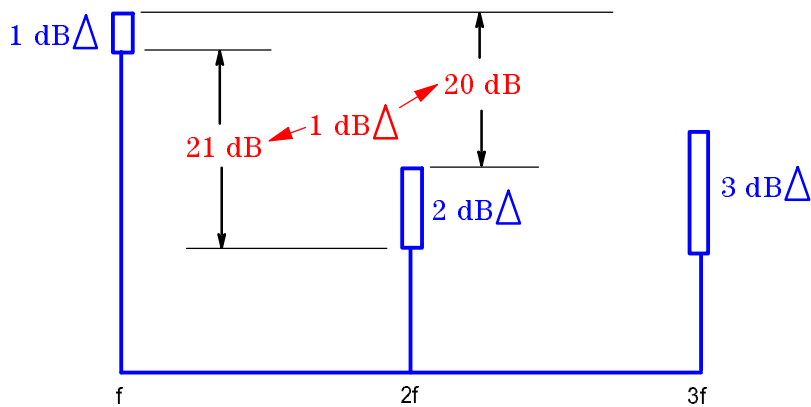

Most distortion measurements are made relative to the fundamental signals (the carrier or two-tones). When the fundamental power is decreased 1 dB, the second-order distortion decreases by 2 dB, but relative to the fundamental, the second-order distortion decreases 1 dB. There is a one-for-one *relative* relationship between the fundamental and second-order distortion.

When the fundamental power is decreased 1 dB, the third-order distortion decreases 3 dB, but relative to the fundamental, the third-order distortion decreases 2 dB. There is a two-for-one *relative* relationship between the fundamental and third-order distortion.

Spectrum Analysis Basics

Slide #48

Specifications

Distortion

Distortion is a Function of Mixer Level

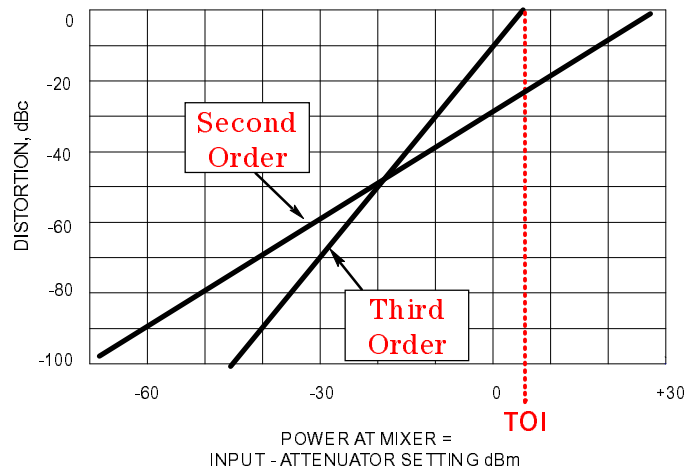

Spectrum Analysis Basics
CMB 12/96

Understanding this concept is useful in determining distortion within the analyzer. Here we plot the level of the second- and third-order distortion products relative to the signals that cause them. The x-axis is the signal power at the first mixer (in this case the level of the tone or tones). The y-axis is the spectrum analyzer's internally-generated distortion level in dBc (dB below the signal level at the mixer). These curves are *signal-to-distortion curves*.

Note the slopes of the second- and third-order curves. The slope is unity for the second-order, because every dB change in fundamental level equally changes the level of the second harmonic-distortion component relative to the fundamental. The third-order curve has a slope of two because the relationship between fundamental and third-order distortion products changes twice as fast as the fundamental. Thus, if analyzer distortion is specified for one signal level at the mixer, distortion at any other level can easily be determined. This example shows that for a level of -40 dBm at the mixer, third-order distortion is -90 dBc and second-order distortion is -65 dBc.

The mixer level at which third-order distortion equals the fundamental, 0 dBc, (a condition which could never happen because compression in the mixer would occur first) is useful to know because a simple expression then permits computation of third-order distortion at any mixer level. This reference point is called the third-order intercept or TOI. This is a common spectrum analyzer specification, and is used to determine the maximum dynamic range available for a particular measurement. In the above figure, TOI = +5 dBm.

Spectrum Analysis Basics

Slide #49

Specifications

Distortion

Distortion Test: Is it Internally or Externally Generated?

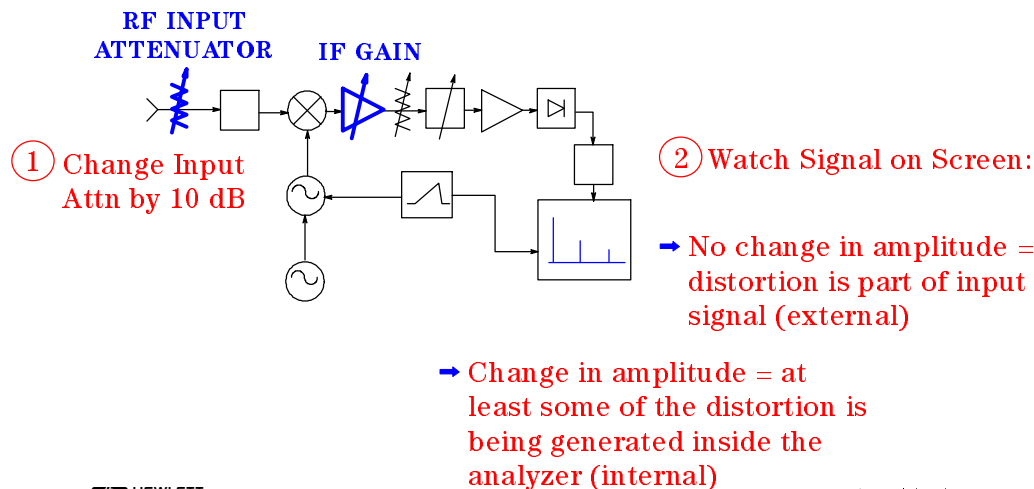

Before leaving this section on distortion, there is a test that should be done for all distortion measurements. The test is going to tell us whether or not what we are seeing on the screen is internally generated distortion, or distortion caused by the DUT.

Remember from our discussion on the components inside the spectrum analyzer, that the RF input attenuator and the IF gain are tied together such that input signals will remain stationary on the screen when we adjust the RF input attenuation for high-level input signals (to prevent too much power into the mixer). This is because the IF gain automatically compensates for these changes in input attenuation.

If the distortion product on the screen *does not* change when we change the RF input attenuation, we can be sure it is distortion from the DUT (i.e. part of the input signal). The 10 dB attenuation applied to the signal is also experiencing the 10 dB gain from the IF gain and therefore, there is no change.

If however, when we change the RF input attenuation the signal on the screen *does* change, then we know it must be being generated, at least in part, somewhere *after* the input attenuator, (i.e. the analyzer's internally generated distortion from the first mixer), and not totally from the DUT. The 10 dB attenuation is *not* applied to this internal signal (since it is actually generated *after* the attenuator), yet the 10 dB gain *is* applied to it, therefore increasing its level by as much as 10 dB.

Spectrum Analysis Basics

Slide #50

Specifications

Dynamic Range

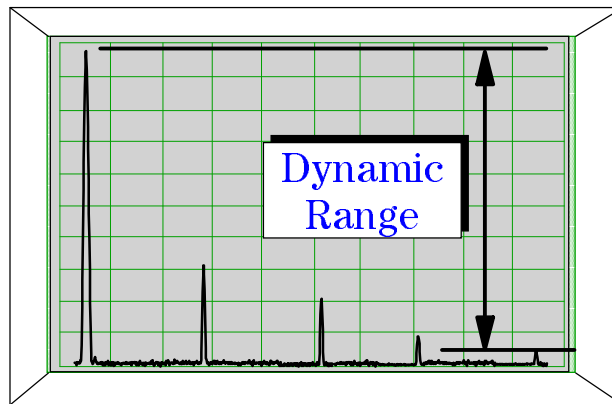

Dynamic Range is defined as the maximum ratio of two signal levels simultaneously present at the input which can be measured to a specified accuracy. You can imagine connecting two signals to the analyzer input - one which is the maximum allowable level for the analyzer's input range and the other which is much smaller. The smaller one is reduced in amplitude until it is no longer detectable by the analyzer. When the smaller signal is just measurable, the ratio of the two signal levels (in dB) defines the dynamic range of the analyzer.

What effects might make it undetectable? All the things we've just discussed. Such things as residual responses of the analyzer, harmonic distortion of the large signal (due to analyzer imperfections), and the internal noise of the analyzer. These will all be large enough to cover up the smaller signal as we decrease its amplitude. The dynamic range of the instrument determines the amplitude range over which we can reliably make measurements.

Spectrum Analysis Basics

Slide #51

Specifications

Dynamic Range

Signal-to-Noise Ratio Can Be Graphed

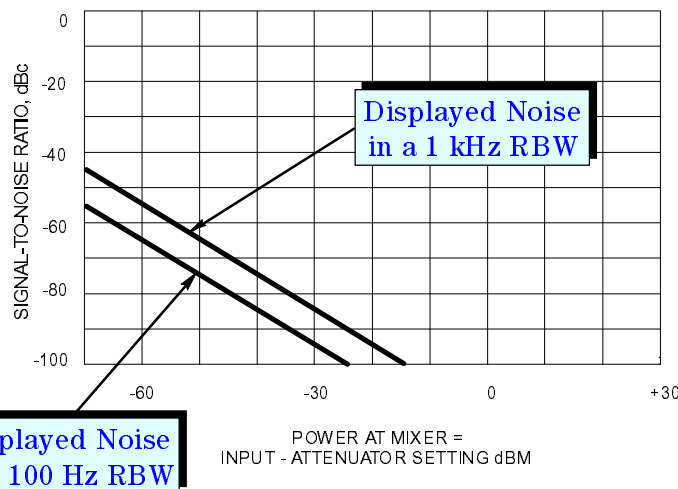

On page 48, we plotted the signal-to-distortion curves. This graph is actually called a dynamic range graph, and just as we plotted distortion products as a function of mixer power, we can also plot *signal-to-noise ratio* (SNR) as a function of mixer power.

The signal-to-distortion curves tell us that maximum dynamic range for distortion (minimum distortion in dBc) occurs at a minimum power level to the input mixer. We know, however, that spectrum analyzer noise also affects dynamic range. The dynamic range graph for noise (above) tells us that best dynamic range for noise occurs at the highest signal level possible.

We have a classic engineering trade-off. On the one hand, we would like to drive the level at the mixer to be as large as possible for the best signal-to-noise ratio. But on the other hand, to minimize internally generated distortion, we need as low a drive level to the mixer as possible. Hence the best dynamic range is a compromise between signal-to-noise and internally generated distortion.

Spectrum Analysis Basics

Slide #52

Specifications Dynamic Range

Dynamic Range Can Be Presented Graphically

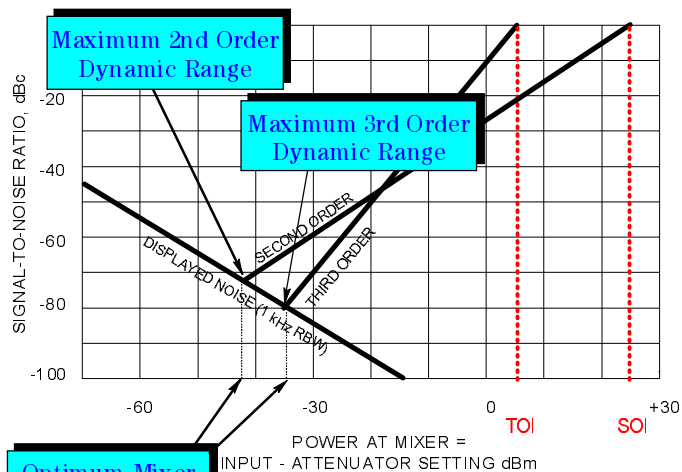

Spectrum Analysis Basics
CMB 12/96

Let's plot both the signal-to-noise and signal-to-distortion curves on one dynamic range graph. *Maximum dynamic range* occurs where the curves intersect, that is, when the internally generated distortion level equals the displayed average noise level. This shows two of the dynamic range specifications. We will see that there are others later.

The *optimum mixer level* occurs at the point of maximum dynamic range. If our test tones are at 0 dBm and our attenuator has 10 dB steps, we can choose mixer levels of 0, -10, -20, -30, -40 dBm, etc. Many of these mixer levels will give us enough dynamic range to see third-order distortion products at -50 dBc. However, keeping the internal noise and distortion products as low as possible will minimize errors. A drive level to the mixer between -30 and -40 dBm would allow us to make the measurement with minimum error.

So, which mixer level do we choose? For < 1 dB uncertainty in your measurement, the signal-to-internal-distortion must be 19 dB, whereas the signal-to-noise only 5 dB. This tells us that it is best to stay closer to the noise, so we would set mixer level to -40 dBm (the mixer level to the left of the third-order point of intersection). This results in a "spurious free display".

Spectrum Analysis Basics

Slide #53

Specifications

Dynamic Range

Calculated Maximum Dynamic Range

$$\text{MDR}_3 = 2/3 (\text{DANL} - \text{TOI})$$

$$\text{MDR}_2 = 1/2 (\text{DANL} - \text{SOI})$$

$$\text{Where TOI} = \text{Mixer Level} - \text{dBc}/2$$

$$\text{SOI} = \text{Mixer Level} - \text{dBc}$$

$$\text{Optimum Mixer Level} = \text{DANL} - \text{MDR}$$

$$\text{Attenuation} = \text{Signal} - \text{Optimum Mixer Level}$$

Maximum dynamic range is easy to calculate, as shown on the slide.

MDR_3 = maximum third-order dynamic range

MDR_2 = maximum second-order dynamic range

TOI = Third-order intercept

SOI = Second-order intercept

DANL = Displayed average noise level

Mixer level = signal level - attenuation

Optimum mixer level = mixer level for maximum dynamic range

Remember that TOI and DANL are typical spectrum analyzer specifications found on the datasheet. Let's do an example calculation.

Spectrum Analysis Basics

Slide #54

Specifications

Dynamic Range

Example Calculation

$$\begin{aligned} \text{MDR}_3 &= 2/3 [(-115) - (+5)] \\ &= -80 \text{ dBc (1 kHz RBW)} \end{aligned}$$

$$\begin{aligned} \text{Where TOI} &= (-30) - (-70)/2 \\ &= +5 \text{ dBm} \end{aligned}$$

$$\begin{aligned} \text{Optimum Mixer Level} &= (-115) - (-80) \\ &= -35 \text{ dBm} \end{aligned}$$

$$\begin{aligned} \text{Attenuation} &= (0) - (-35) \\ &= +35 \text{ dBm} \end{aligned}$$

For example, let's say we have a spectrum analyzer with a DANL = -115 dBm (1 kHz RBW), and TOI = +5 dBm. This slide shows how to calculate maximum third-order dynamic range (MDR_3), optimum mixer level, and attenuation.

Remember that for every order of magnitude decrease in RBW, the DANL decreases by 10 dB (page 40). Therefore, DANL = -135 for a 10 Hz RBW, and third-order dynamic range improves by 13 dB, $[2/3(-140)] = 93 \text{ dBc}$.

Spectrum Analysis Basics

Slide #55

Specifications Dynamic Range

Dynamic Range for Spur Search Depends on Closeness to Carrier

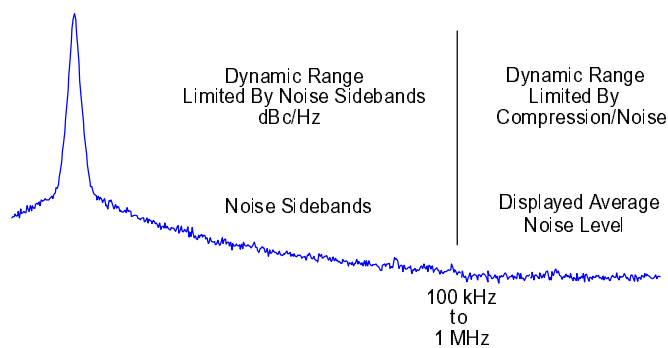

The final factor in dynamic range is the phase noise, or noise sidebands, on our spectrum analyzer LO.

An example application where we can see how both the noise sidebands and the displayed average noise limits dynamic range is when making spur measurements. As can be seen on the slide, the dynamic range for the close-in, low-level spurs is determined by the noise sidebands within approximately 100 kHz to 1 MHz of the carrier (depending on carrier frequency). Beyond the noise sidebands, the dynamic range is the compression-to-noise (displayed average noise) ratio.

Another example is when the signals are so close together that noise sidebands limit dynamic range (e.g. a two-tone measurement where the tones are separated by 10 kHz, therefore producing third-order distortion products 10 kHz from the test tones). In this case, instead of -80 dB dynamic range, the noise sidebands in a 1 kHz RBW limit our achievable dynamic range to -60 dBc per 1 kHz RBW (for specified noise sidebands of -90 dBc/Hz at a 10 kHz offset). For distortion tests, the phase noise can also be plotted on the dynamic range graph as a horizontal line at the level of the phase noise specification at a given offset.

NOTE: The dynamic range curves we've just discussed are needed only for distortion tests.

Spectrum Analysis Basics

Slide #56

Specifications

Dynamic Range

Actual Dynamic Range is the Minimum of:

Maximum dynamic range calculation

Calculated from:

- distortion
- sensitivity

Noise sidebands at the offset frequency

We have seen that the dynamic range of a spectrum analyzer is limited by three factors: the broadband noise floor (sensitivity) of the system, the distortion performance of the input mixer, and the phase noise of the local oscillator. The first two factors are used to calculate maximum dynamic range. Therefore, actual dynamic range is the minimum of 1) the MDR calculation and 2) the noise sidebands.

Spectrum Analysis Basics

Slide #57

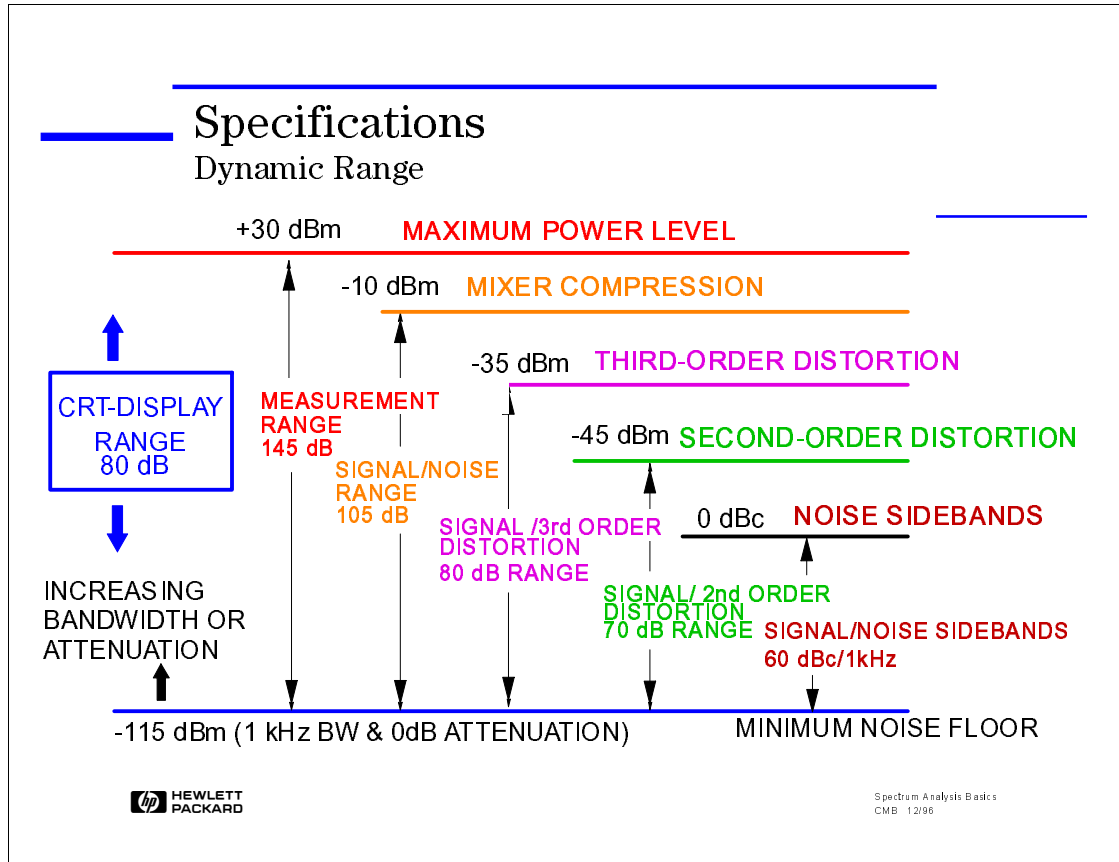

There are several ranges associated with the spectrum analyzer. Typically the term "dynamic range" only refers to the ability to measure two signals *at the same time*.

Display range refers to the *calibrated* amplitude range of the CRT display. For example, some analyzers with a display having eight divisions might only have a 70 dB display range when we select 10 dB per division because the bottom division is not calibrated.

Measurement range is the ratio of the largest to the smallest signal that can be measured under any circumstances - *but not at the same time*. The upper limit is determined by the maximum safe input level, +30 dBm (1 Watt) for most analyzers. Sensitivity sets the other end of the range.

The other four ranges (signal/noise, signal/third order distortion, signal/second order distortion, and signal/noise sidebands) are when measuring two signals at the same time, and therefore are called dynamic range specifications. To summarize what we've learned about dynamic range then, we can compare the four dynamic range values above. We see that the noise sidebands limit the dynamic range the most, whereas the spectrum analyzer noise floor (sensitivity) limits it the least. This agrees with what we've learned from the dynamic range graphs and about noise sidebands.

Spectrum Analysis Basics

Slide #58

Agenda

- 
- Overview
 - Theory of Operation
 - Specifications
 - **Features**
 - **Summary**

Now that we have a fairly basic understanding of the important characteristics of a spectrum analyzer, let's take a look at some features and special functions that most analyzers have available (either standard or optional), that can increase the usefulness, effectiveness, and ease-of-use of the analyzer.

Spectrum Analysis Basics

Slide #59

Features

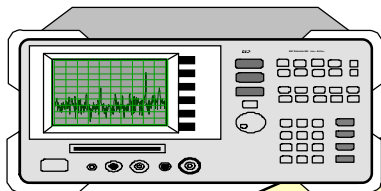

► Basic Operation

- ✓ remote operation
- ✓ markers
- ✓ limit lines

► Modulation Measurements

- ✓ time domain
- ✓ FFT
- ✓ AM/FM detector
- ✓ time-gating

► Noise Measurements

- ✓ noise marker
- ✓ averaging

► Stimulus Response Measurements

- ✓ tracking generator

The features are categorized into application areas, in order to better describe their function. The first group, under Basic Operation, are some of the key features that enhance the use of the analyzer for any application. The others refer to a specific application, although the feature is not necessarily used *only* in that application.

Details of the applications themselves will not be given here, as this is not the purpose of this paper.

Spectrum Analysis Basics

Slide #60

Features

Basic Operation: Remote Operation, Markers & Limit Lines

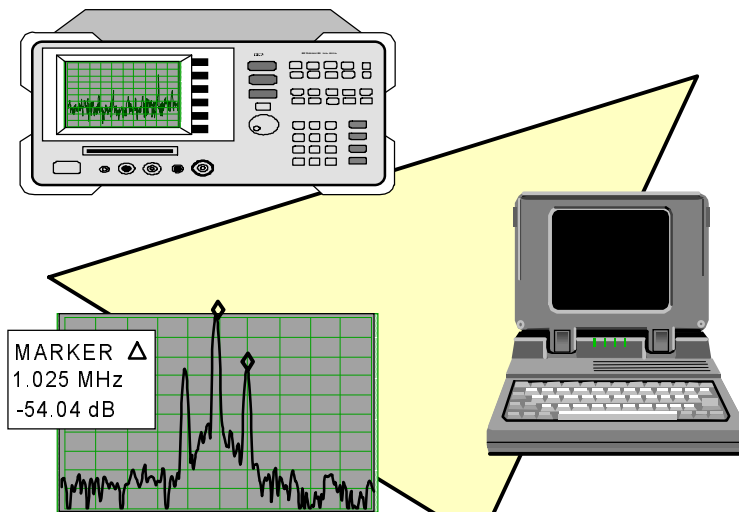

**HEWLETT
PACKARD**

Spectrum Analysis Basics
CMB 12/96

Automated/remote operation: Computers can be used to directly control the operation of spectrum analyzers over HP-IB. Computers can also be used to develop downloadable programs (DLPs) for spectrum analyzers. The analyzer can then store these programs in non-volatile memory. These custom measurement routines are then as easy to use as any of the standard instrument features. Custom measurement "personality" cards are available for many spectrum analyzers for making measurements such as noise figure, phase noise, and several digital communications tests, far faster and easier.

In addition, spectrum analyzers with parallel or RS-232 capability can directly control a plotter or printer, enabling a hard copy of the CRT display to be made without the use of a computer. Analyzers with HP-IB capability can easily be used with the addition of an HP-IB to parallel converter.

Application areas that require accurate, high-speed, repetitive routines; physical separation of the operator and the analyzer; unattended operation or operation by personnel with limited technical skills - all are candidates for automation.

Markers: Markers allow you to quickly and accurately find the amplitude and frequency of signal peaks, and determine the differences between peaks.

Limit lines: Modern spectrum analyzers provide electronic limit-line capability. This allows you to compare trace data to a set of amplitude and frequency (or time) parameters while the spectrum analyzer is sweeping the measurement range. When the signal of interest falls within the limit line boundaries, the analyzer displays a PASS message. If the signal should fall out of the limit line boundaries, a FAIL message will appear. This makes go/no go testing a snap!

Spectrum Analysis Basics

Slide #61

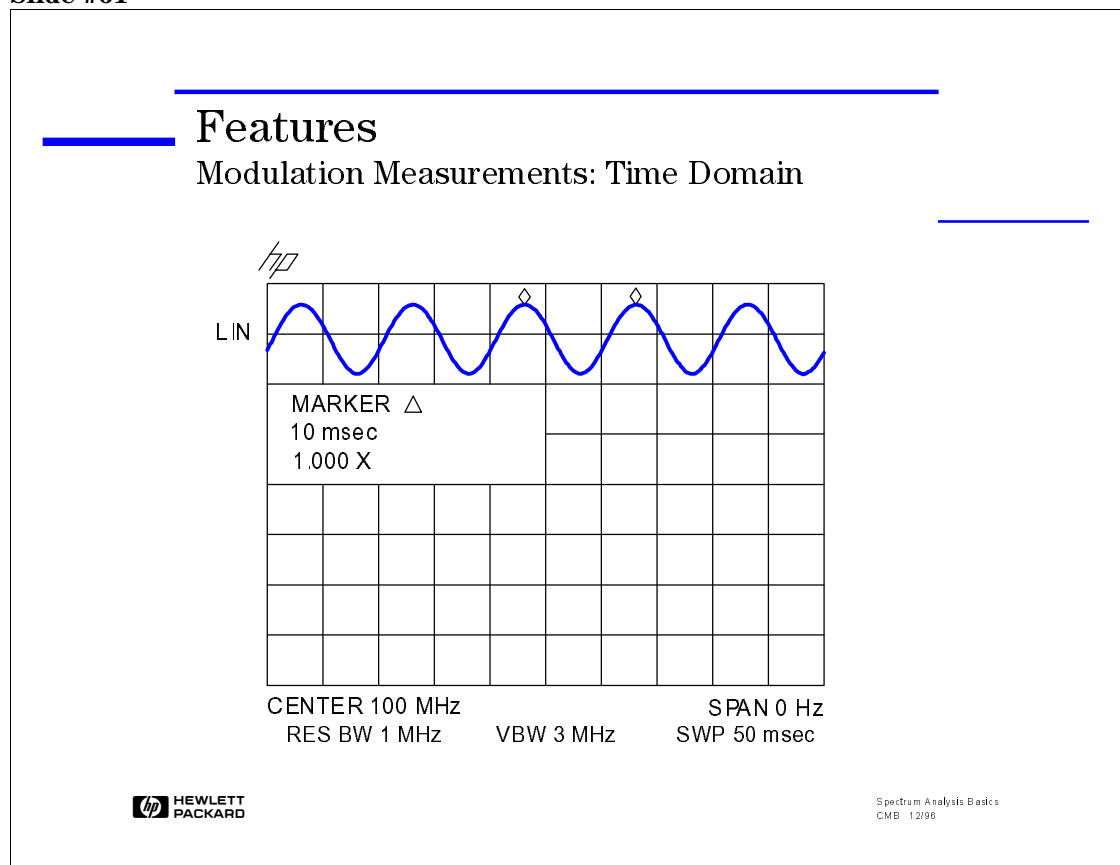

It was mentioned briefly that although a spectrum analyzer is primarily used to view signals in the frequency domain, it is also possible to use the spectrum analyzer to look at the time domain. This is done with a feature called zero-span. This is useful for determining modulation type or for demodulation.

The spectrum analyzer is set for a frequency span of zero (hence the term zero-span) with some nonzero sweep time. The center frequency is set to the carrier frequency and the resolution bandwidth must be set large enough to allow the modulation sidebands to be included in the measurement. The analyzer will plot the amplitude of the signal versus time, within the limitations of its detector and video and RBWs. A spectrum analyzer can be thought of as a frequency selective oscilloscope with a BW equal to the widest RBW.

The slide is showing us an amplitude modulated signal using zero-span. The display is somewhat different than that of an oscilloscope. The spectrum analyzer uses an envelope detector, which strips off the carrier. Hence, only the baseband modulating signal (the demodulated signal) is seen.

The display shows a delta marker of 10 ms. Since this is the time between the two peaks, the period T is 10 ms. Recall that period $T = 1/f_{mod}$ (where f_{mod} = modulation frequency). Hence, f_{mod} is 100 Hz.

This feature cannot be used for quickly varying signals, since the minimum sweeptime of most analyzers is typically slower than would be necessary. Zero-span operation is not limited to modulation measurements. It can be used to characterize any signal that is slowly varying in amplitude, such as a broadcast signal experiencing atmospheric fading.

Spectrum Analysis Basics

Slide #62

Features

Modulation Measurements: FFT

Swept Frequency Domain

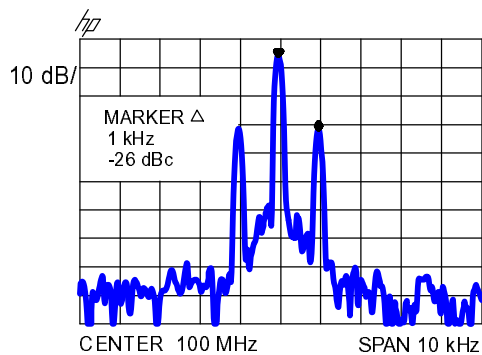

FFT Frequency Domain

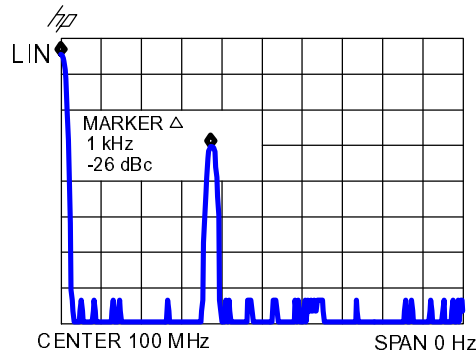

Spectrum Analysis Basics
CMB 12/96

Another common measurement made on an AM signal (besides determining the modulation frequency) is modulation index, which tells us the degree of modulation (0 to 100%).

The graph on the left is a typical swept-frequency-domain plot of the amplitude modulated signal. Remember that we need the RBW to be $\ll f_{\text{mod}}$ in this case, so that the sidebands can be clearly observed. In the frequency domain, f_{mod} is the frequency separation of the sidebands. The amplitude of these sidebands, relative to the carrier, tells us the level of modulation. The equation that allows us to convert this relative sideband amplitude back to modulation index is: $m = 2 \times 10^{(A_{\text{dB}}/20)}$, where A_{dB} is the sideband amplitude relative to the carrier, expressed in decibels. For this example then, $m = 0.1$ or 10%.

Using the FFT (Fast Fourier Transform) function is another way to make this measurement. Remember in the very beginning we talked about Fourier analyzers. We mentioned that they basically take the time-domain information and convert it to the frequency-domain via mathematical relationships. Some spectrum analyzers have a function that does this same thing. While in the time-domain (now, RBW should be $> f_{\text{mod}}$ to include sidebands), the FFT function can be accessed. This causes the analyzer to display the frequency-domain based on the FFT of the time-domain (not by directly measuring it). The graph on the right is an example of what you would see in the FFT-frequency-domain. The carrier is at the left edge because it is at 0 Hz relative to itself. The baseband modulating signal (upper sideband) is to the right of the carrier, offset from the carrier by f_{mod} . The frequency range (span) depends on sweep time. Just like in the swept-frequency-domain, the markers can be used to measure carrier amplitude, m , and f_{mod} . As shown, the delta marker reads 1000 Hz and -26 dBc. Hence $f_{\text{mod}} = 1$ kHz and $m = 10\%$.

Spectrum Analysis Basics

Slide #63

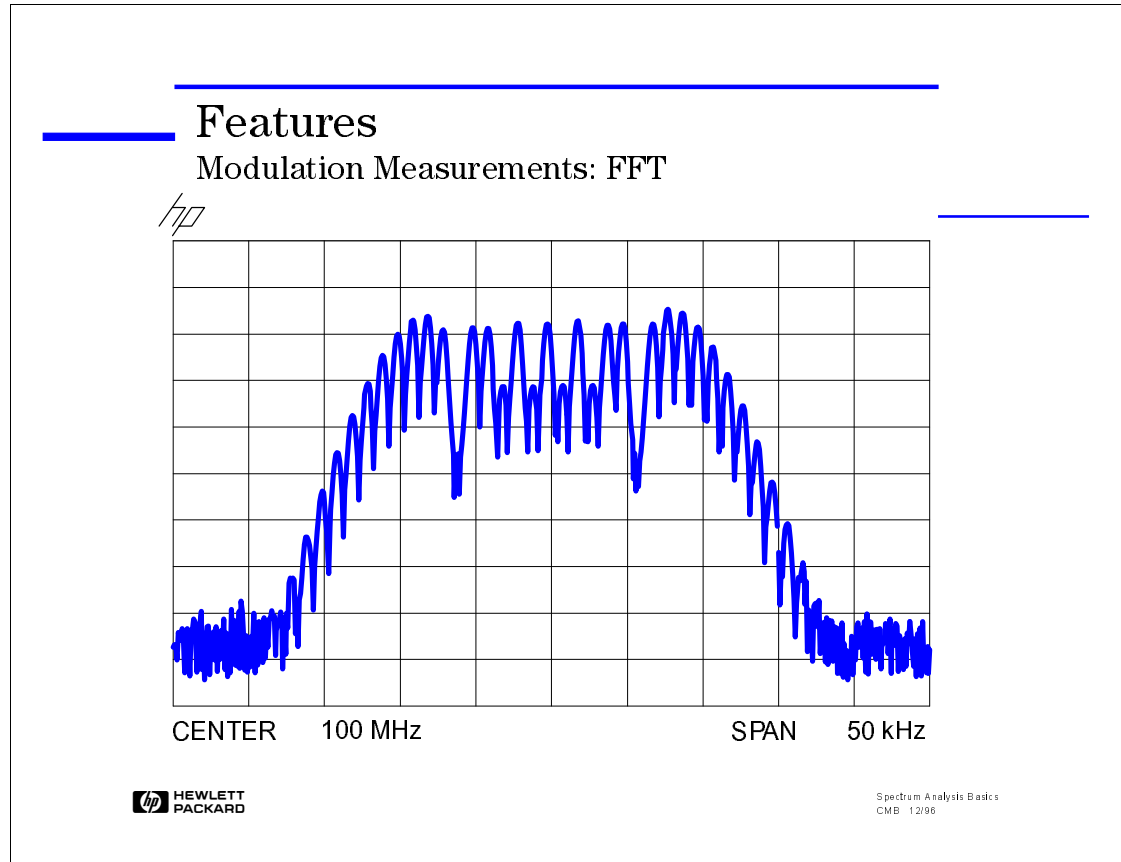

We've just seen how modulation frequency and AM depth of modulation measurements using a spectrum analyzer can be made in both the swept-frequency-domain and the FFT-frequency-domain. So why would you want to use the FFT function?

This slide shows a carrier that has both AM and FM (f_{mod} is 1 kHz). The amount of FM is much larger than the amount of AM, so it is impossible to measure the percent AM of this signal in the swept-frequency-domain.

However, in the FFT-frequency-domain and using a wide RBW, we can easily measure the AM in the above signal. This is because using a wide RBW in combination with envelope detection "strips off" the FM (FM becomes a line on the display since there are no amplitude variations), leaving only the AM. Measurement with the FFT yields the same result as shown in the previous slide.

In addition, the FFT-frequency-domain gives us better amplitude accuracy, frequency resolution, and orders-of-magnitude improvement in speed. The only disadvantage of the FFT is that relative frequency accuracy is not as good as in the swept-frequency-domain.

Spectrum Analysis Basics

Slide #64

Features

Modulation Measurements: AM/FM Detector with Speakers

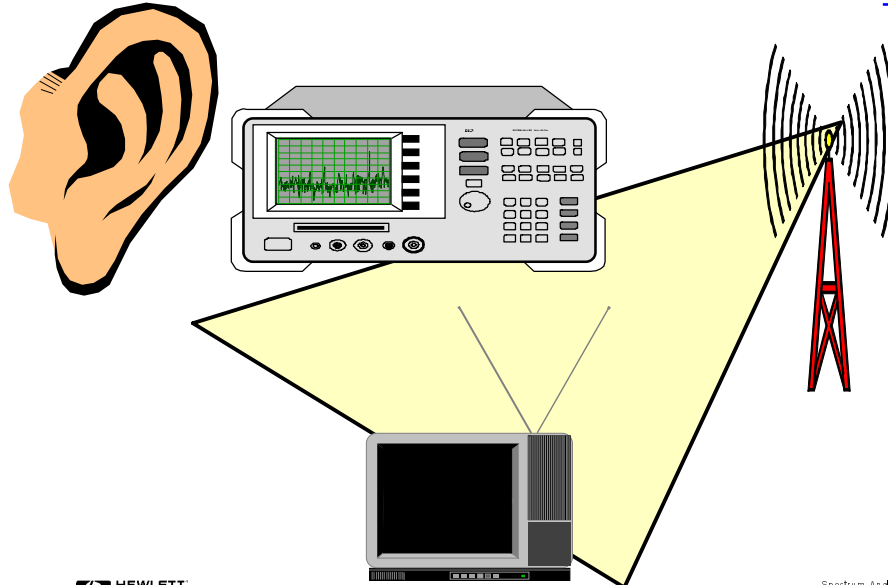

 HEWLETT
PACKARD

Spectrum Analysis Basics
CMB 1296

Most modern spectrum analyzers have available AM/FM detection with speakers. The built-in AM/FM detectors with speaker allow you to hear the modulation. In other words, they allow you to hear the source of interference as well as see it, for faster identification of interfering signals in communication networks, etc.

"Seeing" a signal in the frequency domain does help in identifying an interfering signal. However, "hearing" the signal is much, much more helpful in determining whether a source of interference is an AM radio station, FM radio station, TV station, amateur radio operator, etc.

Spectrum Analysis Basics

Slide #65

Features

Modulation Measurements: Time-Gating

Time Division Multiple Access (TDMA)

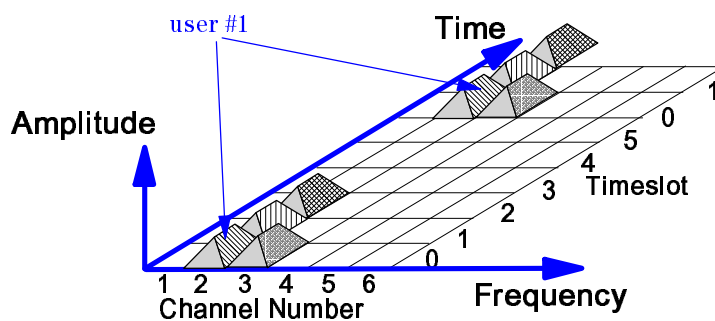

In order to explain the time-gating feature of a spectrum analyzer, we will use a digital communications application, Time-Division-Multiple-Access (TDMA). This is a common method used in communications in order to increase channel capacities in the same frequency bands. TDMA divides up the frequency channels into time slots, so that users can occupy the same frequency, but use different timeslots.

Maintaining the quality of digital service requires measuring the TDMA signal in both the time and frequency domains. The timing of the bursts, as well as the rise and fall times must be tested to verify that bursts in adjacent timeslots do not overlap. In the frequency domain, the quality of modulation can be confirmed by examining the RF spectrum.

When examining the spectrum, it is important to measure the overall pulse modulation effects on the whole channel signal, that is, the effects of turning on and off the transmitter. It is also important to understand the effects due to continuous modulation (only when the pulse is 'on'). The time-gating feature on a spectrum analyzer allows us to do just that.

Spectrum Analysis Basics

Slide #66

Features

Modulation Measurements: Time-Gating

Time-Gated Measurements in the Frequency Domain

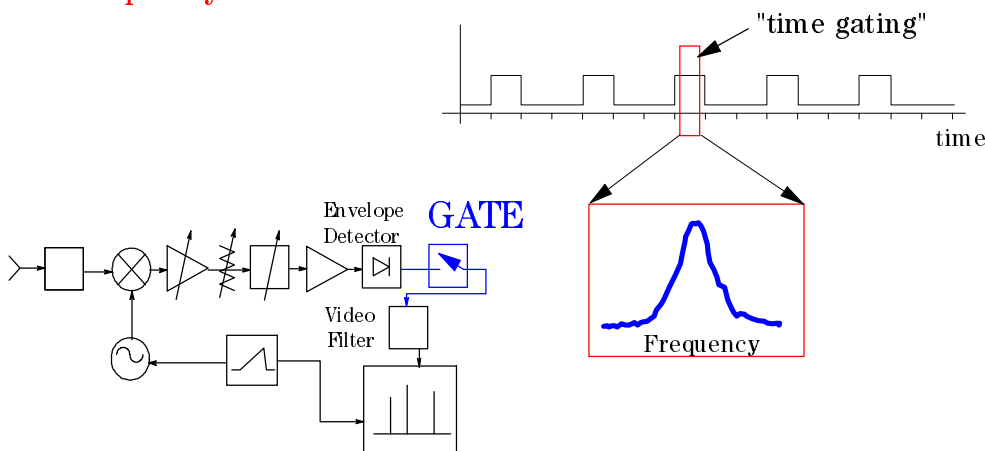

Time-gated, or time-selective spectrum analysis offers a solution to measurement difficulties in the time and frequency domains. Time gating permits precise yet flexible control of the point at which a time domain sweep begins, allowing the sweep to be centered over the desired timeslot. Any timeslot, or portion of a timeslot, may be examined at maximum time resolution.

The implementation in the analyzer is fairly straightforward. A video gate, or switch, is inserted between the envelope detector and the video filter. If both the start of the measurement sweep (gate delay) and the duration of the measurement (gate length) are controlled, the signal will reach the sampling hardware only during the selected time interval. Spectrum analysis can therefore be directed to a time during which the transient spectra (turning on and off of the transmitter) are present. Or, the transient spectral power may be excluded, or time filtered out, revealing the spectra due to continuous modulation.

Spectrum Analysis Basics

Slide #67

Features

Noise Measurements: Noise Marker & Video Averaging

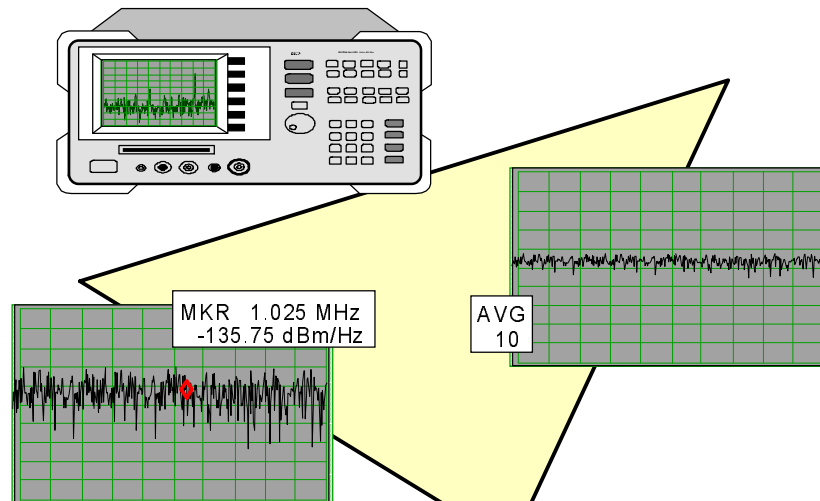

When making measurements on noise, there are a couple of features on a spectrum analyzer that can make the measurements easier and more accurate.

The first is a **noise marker**. When the noise marker is selected, the sample detection mode is activated, the values of a number of consecutive trace elements, or bins (the number depends upon the analyzer) about the marker are averaged, and this average value is normalized to an equivalent value in a 1-Hz noise power bandwidth. The normalization process accounts for detection and bandwidth plus the effect of the log amplifier when we select the log-display mode. This direct reading marker is a great convenience when making noise measurements.

Another feature that is useful when making measurements on random noise, is **video averaging**. This is a digital averaging of a spectrum analyzer's trace information and is only available on analyzers with digital displays. The averaging is done at each point of the display independently and is completed over the number of sweeps selected.

Spectrum Analysis Basics

Slide #68

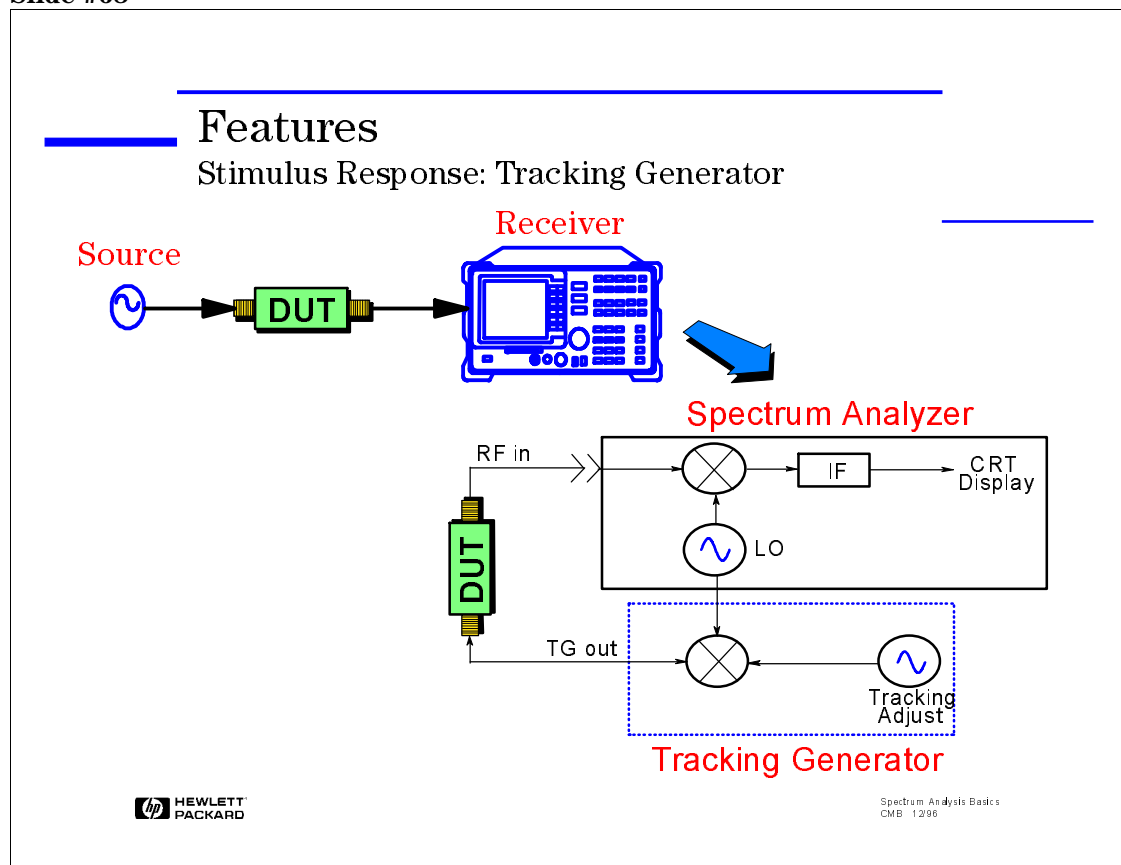

Stimulus response measurements, or network measurements, involve applying a signal to the input of our device/system and measuring the response at the output. Therefore, they require a source to stimulate the DUT and a receiver to analyze the transfer characteristics of the DUT. Common measurements include frequency response, return loss, conversion loss, and gain versus frequency.

The two major instruments capable of making a stimulus-response measurement are a network analyzer and a spectrum analyzer. If phase information is required, a vector network analyzer must be used. To use a spectrum analyzer for making stimulus-response measurements, a tracking generator must be used.

A tracking generator is typically built into the spectrum analyzer and provides a sinusoidal output whose frequency is the same as the analyzer's input frequency. It therefore follows (tracks) the tuning of the spectrum analyzer and allows the spectrum analyzer to perform basic network measurements. The output of the tracking generator is connected to the input of the DUT and the response is measured by the analyzer. As the analyzer sweeps, the tracking generator is always operating at the same frequency and the transfer characteristics of the device can be measured.

Spectrum Analysis Basics

Slide #69

Agenda

- 
- Overview
 - Theory of Operation
 - Specifications
 - Features
 - **Summary**

As you can image, there are entire books describing spectrum analysis as well as the various applications that use spectrum analyzers as a measurement tool. Hopefully, this two-hour seminar has given you a basic understanding of spectrum analysis, and provided you with a foundation for which you can now continue to build more knowledge of making measurements in your particular application area.

The key message we hope to leave you with, is that spectrum analyzers are extremely useful tools for characterizing and analyzing a variety of devices and systems. All it takes is a basic understanding of how they work and their characteristics, in order to use them effectively both for making accurate measurements as well as properly interpreting and analyzing results.

Spectrum Analysis Basics

References

Hewlett-Packard Company, Spectrum Analysis Basics, Application Note 150 (HP publication number 5952-0292, November 1, 1989)

Hewlett-Packard Company, 8 Hints to Better Spectrum Analyzer Measurements , (HP publication number 5965-6854E, December, 1996)

Hewlett-Packard Company, Amplitude and Frequency Modulation, Application Note 150-1 (HP publication number 5954-9130, January, 1989)

Witte, Robert A., Spectrum and Network Measurements, Prentice Hall, Inc., 1993

Date Subject to Change
Copyright© 1997
Hewlett-Packard Company
Printed in U.S.A. 4/97
5965-7920E